

USC-130

11.6" ARM Based Android All-in-One Computer



Features

- Equipped with DeviceOn/iService software for remote device management
- 11.6" TFT display with LED backlight
- Flat bezel-less panel with PCAP touch
- Reserved side hatch for optional peripherals
- Embedded RFID/NFC/Barcode Scanner reader and camera
- Supports VESA (75 x 75 mm) and wall mounting
- IP65-rated front panel
- Supports Power over Ethernet
- 12 ~ 36V wide input range

DeviceOn/iService Specifications



		USC-130AP-BX1XX	USC-130AP-BX2XX
System	CPU	Rockchip RK3288 quad-core Cortex™-A17 (up to 1.8 GHz)	Rockchip RK3399 dual-core Cortex™-A72 (up to 1.8 GHz)/quad-core Cortex™-A53 (up to 1.4 GHz)
Graphics	GPU	Mali-T764	Mali-T860
Memory	Capacity	2 GB onboard (4 GB optional)	
	Flash	16 GB onboard eMMC (32 GB optional)	
	Extension	Micro SD	
Display	Display Size	11.6" widescreen (16:9) TFT color LCD	
	Touchscreen	Projected capacitive touch panel (PCAP flat glass)	
	Max. Resolution	HD: 1366 x 768 FHD: 1920 x 1080 (optional by project)	
	Viewing Angle	HD: Horizontal: ± 45°; Vertical: 20° and 40° FHD: Horizontal: ±85° or 170° total; Vertical: ±85° or 170° total (optional by project)	
	Luminance	HD: 250 cd/m ² FHD: 300 cd/m ² (optional by project)	
	Contrast Ratio	HD: 500:1 FHD: 1000:1 (optional by project)	
I/O	HDMI	1	
	LAN	1 x 10/100/1000 Mbps (supports PoE)	
	Serial Port	1 x (RS-232/485 via jumper), up to 2 (1 x for RS-232 only)	
	USB	2 x USB 2.0 (up to 4)	2 x USB 3.0 (up to 4: 2 x USB 2.0 and 2 x USB 3.0)
	Audio Out	1	
	Mic In	1	
	DC Input	1 x Power jack (12 ~ 36V)	
	Micro SD	1	
	SIM Card	1	
Other	Speaker	2W	
	Mount Options	VESA mount (75 x 75 mm/2.95 x 2.95 in)	
	Hatch	Right/bottom hatch auxiliary mounting for optional modules	
	Adapter	12V/36W	
Optional Peripherals	RFID/NFC (Embedded)	1443A/B, 15693, Filcon	
	Barcode Scanner(Embedded)	1D/2D Code Reorganization	
	Camera (Embedded)	2MP camera module without LED	
	Wi-Fi/Bluetooth	Wi-Fi: 802.11ac/a/b/g/n BT: V5.0 Wi-Fi/ BT combo module	
IP Rating	Front Panel	IP65	
Environmental	Operating Temperature	0 ~ 40 °C /32 ~ 104 °F	
	Humidity	10 ~ 95% @ 40 °C/104 °F (non-condensing)	
Mechanical	Color	Black or white	
	Dimensions (W x D x H)	296 x 189 x 34.9 mm/11.6 x 7.44 x 1.37 in	
	Weight	2 kg/4.4 lb	
Certification	EMI & Safety	FCC, CE, CCC, BSMI, VCCI, UL, CB	
Operating System		Android 8.1, Android 10, Linux	Android 8.1, Android 10, Android 12, Linux

Specifications Cont.

DeviceOn/iService Remote Device Management	Operating System	Android 8, 10, 12
	Common Controls (Reboot, Shutdown)	✓
	Remote desktop	✓ (VNC)
	Device-Specific Controls (Audio, Backlight)	✓
	Connection Status	✓
	Hardware Status	✓
	Batch Operation Support	✓
	OTA Storage Management	Local blob
	OTA Software Updates	✓
	Software Watchlist	✓
	Software Start/Stop	✓
	Kiosk Mode	✓
Peripherals Watchlist	✓	

Note: DeviceOn/iService software must be downloaded from the Advantech website at <https://www.advantech.com/search?q=DeviceOn%2FiService&st=support&sst=Utility>

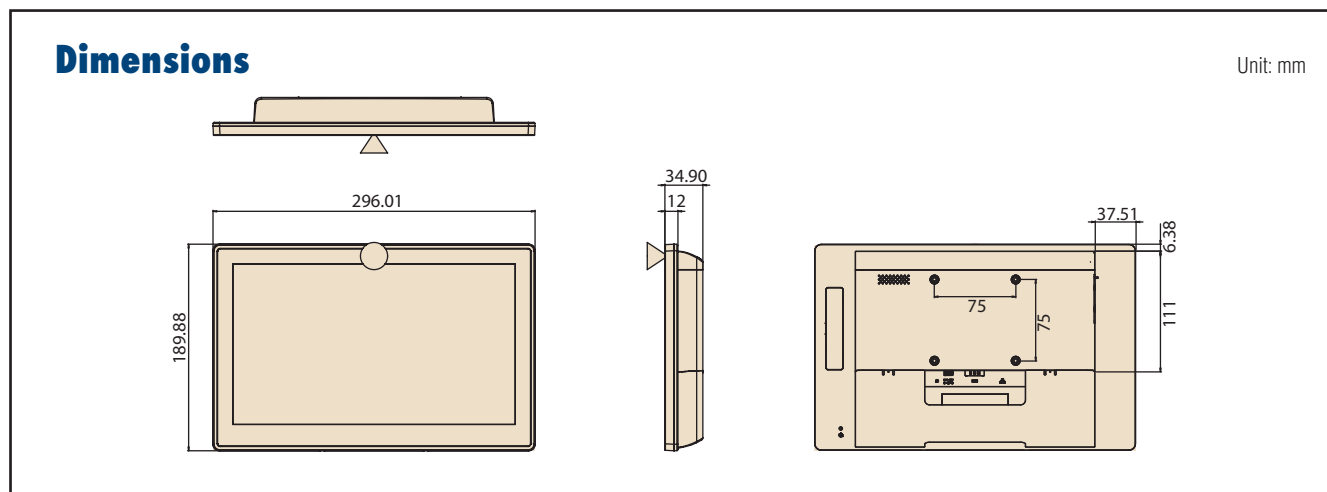

I/O Layout

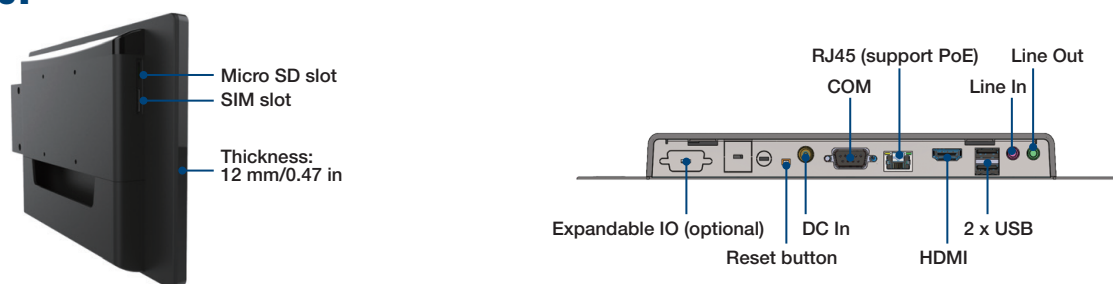

Ordering Information

For Worldwide Model

PN	Description
USC-130AP-BC106	11.6" 16:9 RK3288 2G ram/16G eMMC,HD, Android 10, PoE,no wifi
USC-130AP-BC206	11.6" 16:9 RK3399 2G ram/16G eMMC, HD, Android 10, PoE, no wifi
USC-130BP-BD001	11.6" 16:9 RK3399 2G ram/16G eMMC, HD,Android 12,no wifi

For EU Only Model

PN	Description
USC-130AP-BC201	11.6" 16:9 RK3399 2G ram/16G eMMC, HD, Android 10, WIFI, PoE

Peripherals

Part Number	Description
USC-P03-B200	MSR via USB for USC-MX/1XX
UPOS-P07-A100	Stand, double hinge, VESA 75x75, black
USC-P05-B110	2D barcode scanner
ARES-12240-AR01100	Wall Mount, support 2~10kg, 75/100mm
ARES-12250-L101000	Wall Mount, max. support 25kg, 75/100mm

Accessories

Part Number	Description
96CB-POWER-B-1.8MB	RW 0.75, CCC, black/3L, 180 cm
1700001524	Power cable, UL, 3P, 10A, 125V, 180 cm (US, TW)
170203183C	Power cable 3P, 10A, 250V, 183 cm (EU)
1700018553	Power cable, SAA, 3P, 2.5A, 250V, 183 cm (Australia)
1700025113-11	Power cable, ISI, 3P, 2.5A, 250V, 180 cm (India)
1700018409	Power cable, KCC, 2P, 2.5A, 250V, 183 cm (Korea, Russia)
170203180A	Power cable, BSI, 3P, 2.5A, 250V, 183 cm (UK)
1700008921	Power cable, PSE, 3P, 7A, 125V, 180 cm (Japan)

DeviceOn/iService

Unified Remote Device Management Software





Features

- Supports Advantech devices equipped with Windows, Android, and Linux OS
- Flexible device, location, user, and permissions management
- Enables remote monitoring and control of hardware, software, and peripherals
- Supports over-the-air (OTA) firmware and software updates
- Ensures quick, easy, and secure device onboarding
- RESTful APIs for third-party system integration



Introduction

Advantech's DeviceOn/iService is a next-generation unified device management solution based on the WISE-DeviceOn platform. Designed to enable centralized monitoring and remote management, DeviceOn/iService supports Advantech devices equipped with Windows, Linux, or Android operating systems. The software also supports the management of applications and integrated peripherals, such as a barcode scanner, card reader, camera, and printer. Users can remotely access and control connected devices, take screenshots, rollout OTA upgrades, and use remote desktop capabilities for troubleshooting from any location at any time. Moreover, DeviceOn/iService supports batch operations to facilitate the management of multiple devices simultaneously for easy and convenient device configuration and deployment.



Total Management

- 
Devices & Hardware
 - Windows, Linux, Android
 - Hardware, storage, battery
- 
Software & Peripherals
 - Software monitoring & access
 - Screens, USB devices, printers
- 
Open for Expansion
 - Peripheral integration
 - Open APIs for integration

Remote Access

- 
Real-Time Monitoring
 - Connection/hardware status
 - Software/peripheral status
 - Failure notifications
- 
Remote Controls
 - Power controls
 - Audio, backlight controls
 - Software controls
- 
Troubleshooting
 - Screenshots
 - Remote desktop support

Operational Efficiency

- 
OTA updates
 - System/software updates
 - File repository management
 - App store
- 
Batch Controls
 - 1-to-many batch reboot, etc.
 - Time-saving tasks
- 
Setup Booster
 - Software/peripheral watchlist
 - Roles, rule templates

Note: Some functions may vary according to the product

System Architecture

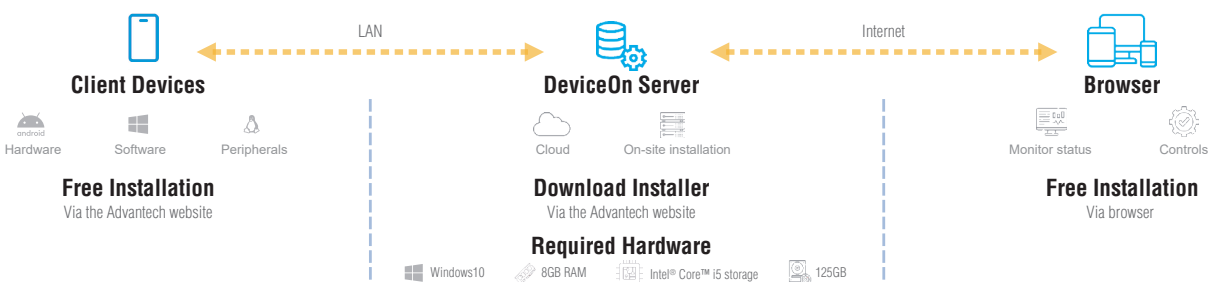

Tento produkt můžete zakoupit u společnosti AutoCont IPC a.s.



AutoCont IPC a.s.

Váš dodavatel průmyslových počítačů, komponent a speciálních průmyslových IT systémů.

 Uhlířská 1064/3, 710 00 Ostrava, Česká republika

 obchod@autocont-ipc.cz

 +420 552 301 002

 www.autocont-ipc.cz



PRŮMYSLOVÉ POČÍTAČE

fanless embedded PC, do racku, ...



POČÍTAČE S DISPLEJEM

panelové PC, terminály, do vozidel, ...



AUTOMATIZACE A SBĚR DAT

převodníky, karty, moduly, switche, ...



PERIFERIE A KOMPONENTY

monitory, klávesnice, desky, skříně, ...



NOTEBOOKY A TABLETY

odolné, windows, android, IP65, ...



INFORMAČNÍ KIOSKY

interiérové, venkovní, ...



MEDICÍNSKÁ TECHNIKA

počítače, tablety, LCD, klávesnice, ...



SOFTWAREVÁ ŘEŠENÍ

pro výrobu, zaměstnance, kiosky, ...



PŘEJÍT DO E-SHOPU

eshop.autocont-ipc.cz



DOPRAVA ZDARMA

Doprava zdarma v ČR a SR při objednávce nad 10 000 Kč bez DPH nebo nad 400 EUR.



PRODLOUŽENÁ ZÁRUKA

Záruka 2 roky na vyráběné počítače s možností jejího prodloužení až na 5 let.



ODMĚNA ZA VĚRNOST

Pravidelní zákazníci u nás nakupují za nižší ceny. Výše slevy se odvíjí od realizovaného obrátu.



SERVIS ON-SITE A IN-TIME

K projektovým dodávkám nabízíme rozšířenou podporu a servis s garancí výměny zařízení do 48 hodin.