

UNO-3283G / 3285G

Intel® Core™ i Automation Computer with 2/4 PCI(e) Expansion Slots

NEW



UNO-3283G

UNO-3285G



Features

- Intel® 6th Gen Core™ i7-6822EQ/ i5-6442EQ/ i5-6440EQ/ i3-6102E Processors with 8GB DDR4 memory
- 2 x GbE, 6 x USB 3.0, 2 x RS-232/422/485, 2 x RS-232 (pin header), 1 x DVI-I, 1 x HDMI
- UNO-3283G: 1 x PCIe x16, 1x PCI, 2 x mPCIe (2 x full), 1x CFAST slot, 1 x mSATA slot (optional)
- UNO-3285G: 2 x PCIe x8, 2 x PCI, 2 x mPCIe (2 x full), 1x CFAST slot, 1 x mSATA slot (optional)
- Dual Hot-Swappable storage with thumb screw support for RAID 0/1
- Supports Fieldbus protocol by iDoor technology
- Dual power input for power redundancy
- Front LED indicator design for monitoring system status

Introduction

The high-performance fanless control cabinet PC UNO-3283G/ 3285G equipped with an Intel® 6th Gen Core™ i7/ i5/ i3 processor and QM170 PCH chipset, rich I/O including 6 x USB 3.0, 2 x GigaLAN, 2 x RS-232/422/485, and 2 x RS-232 (pin header) ports, as well as DVI-I and HDMI display interfaces, UNO-3283G/ 3285G is designed to deliver high-performance computing and maximum flexibility for industrial automation applications. The provision of two hot-swappable HDD/SSD bays and up to 4 expansion slots (2 x PCIe x8, 2 x PCI) supports the integration of modular peripherals and ensures flexible installation in diverse cabinet configurations. In addition to an exchangeable RTC battery that can be accessed via the removable top cover for convenient maintenance, the system features dual power inputs that ensure a stable power supply.

Specifications

General

- Certification** CE, UL, CCC, FCC, BSMI
- Dimensions (W x D x H)** UNO-3283G: 142 x 238 x 177 mm (5.6" x 9.4" x 7")
UNO-3285G: 182 x 238 x 177 mm (7.2" x 9.4" x 7")
- Form Factor** Regular Size
- Mounting** Wall mount, Stand mount, Enclosure mount
- Weight (Net)** 4kg (2.2 lbs)/ 4.5kg (9.9 lbs)
- Power Requirements** 12-36 V_{DC}
- Power Consumption** 44W (Typical), 120W (Max)
- OS Support** WIN7/8, WES7, Win10 Ent. LTSC, AdvLinuxTU

System Hardware

- BIOS** AMI UEFI 128Mbit Flash BIOS
- Watchdog Timer** Programmable 255 levels timer interval, from 1 to 255 sec
- Processor** Intel® Core™ i7-6822EQ 2.0GHz Quad Core, 8MB L2
Intel® Core™ i5-6442EQ 1.9GHz Quad Core, 6MB L2
Intel® Core™ i5-6440EQ 2.7GHz Quad Core, 6MB L2
Intel® Core™ i3-6102E 1.9GHz Dual Core, 3MB L2
- System Chip** Intel QM170
- Memory** Built-in 8GB DDR4 2133 MHz, two sockets support up to 32GB
- Graphics Engine** Intel HD Graphics
- Ethernet** LAN A: Intel® i210-IT GbE, IIEEE802.1AS, 802.3az
LAN B: Intel® i219-LM GbE, Intel® AMT, IIEEE802.1AS, 802.3az
- LED Indicators** LEDs for Power, LAN, COM (Tx/Rx), battery and HDD
- Storage** One mSATA slot; One CFAST slot
Two built-in 2.5" SATA HDD brackets with support for RAID 0/1. (Compatible with 9.5mm height HDD)
- Expansion** UNO-3283G: 2 Full-size mPCIe, 1 x PCIe x16, 1 x PCI
UNO-3285G: 2 Full-size mPCIe 2 x PCIe x8, 2 x PCI

I/O Interfaces

- Serial Ports** 2 x RS-232/422/485 with DB9 connectors
RS-485 auto flow control, 50~115.2kbps, 2 x RS-232 (optional pin header)
- LAN Ports** 2 x RJ45, 10/100/1000 Mbps IEEE 802.3u
1000BASE-T Fast Ethernet
- USB Ports** 6 x USB 3.0 Ports
- Displays** 1 x DVI-I, supports 1920 x 1080 @ 60Hz 24bpp
1 x HDMI 1.4a, supports 1920 x 1080 @ 60Hz 24bpp
- Audio** Mic-in, Line-In, Line-Out (Pin Header) (Optional)
- Power Connector** 2 x 3 Pin, terminal Block to support dual power input and relay output

Environment

- Operating Temperature** -20 ~ 60°C (-4 ~ 140°F) with 0.7m/s airflow environment
0~50°C (32 ~ 122°F) for UNO-3283G-6541AE
- Storage Temperature** -40 ~ 85°C (-40 ~ 185°F)
- Relative Humidity** 10 ~ 95% RH, non-condensing
- Shock Protection** Operating, IEC 60068-2-27, 50G, half sine, 11ms (SSD)
- Vibration Protection** Operating, IEC 60068-2-64, 4Grms, random, 5 ~ 500Hz, 1hr/axis (SSD); 1.5Grms, random, 5 ~ 500Hz, 1hr/axis (HDD)

Dimensions

Unit: mm

UNO-3283G

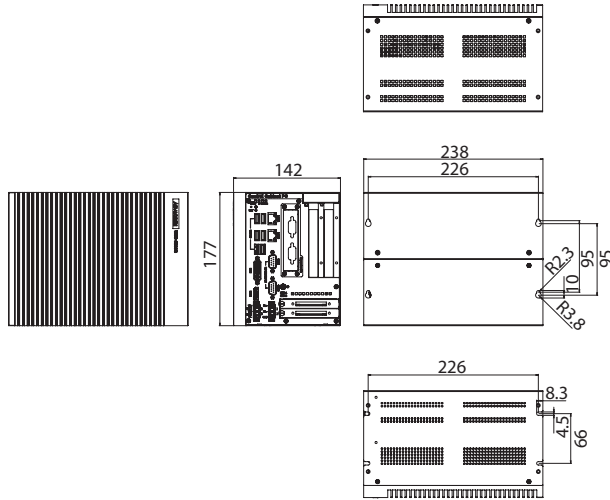

UNO-3285G

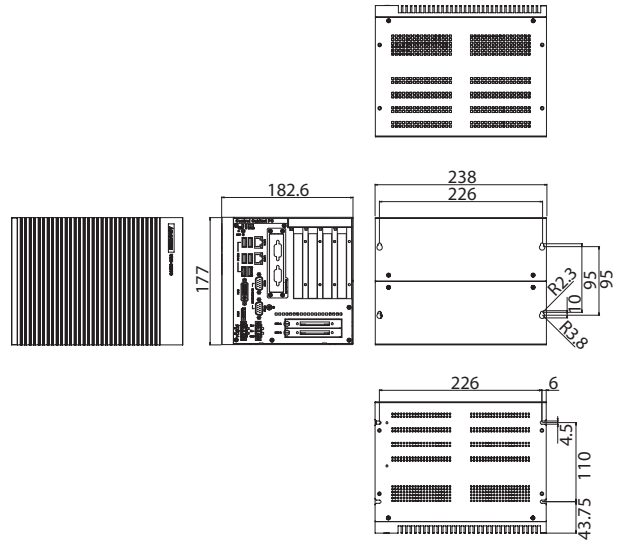

Installation Scenario

Stand mount

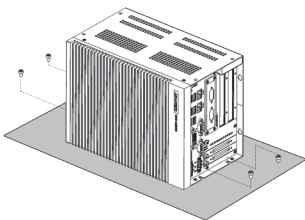

Wall mount

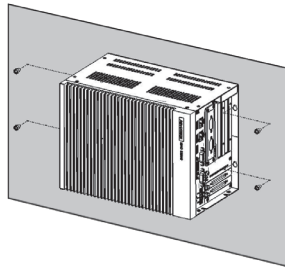

Enclosure Mount

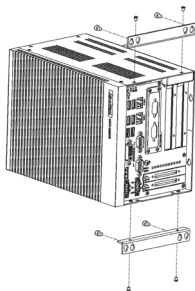

Wall mount

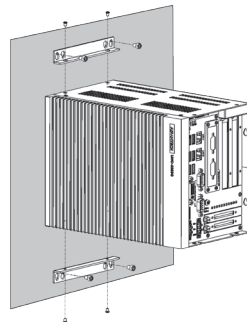

*Mounting kit included in default package

I/O View

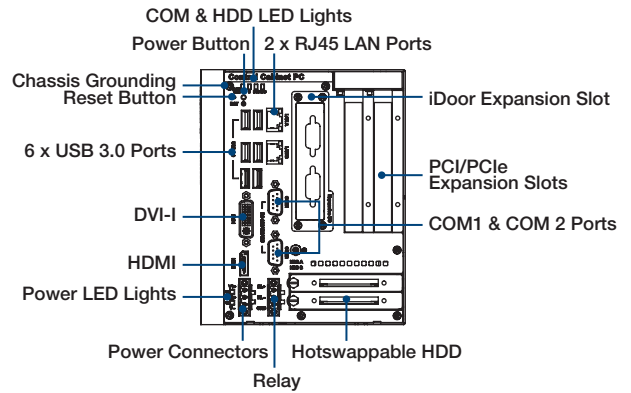

Please note: If some optional modules are offered with the system, additional system certificates may be required in certain regions/countries. Please contact Advantech for certificate compliance.

Ordering Information

Model	Ordering Part Number	CPU	PCI/PCIe	mPCIe	LAN	COM	USB
UNO-3283G	UNO-3283G-634BE	i3-6102E	1 PCIe16 1 PCI	2	2	2	6
	UNO-3283G-654BE	i5-6442EQ					
	UNO-3283G-674BE	i7-6822EQ					
UNO-3285G	UNO-3285G-634BE	i3-6102E	2 PCIe8 2 PCI				
	UNO-3285G-654BE	i5-6440EQ					
	UNO-3285G-674BE	i7-6822EQ					

*Below Part Number had been announced end of life

Model	Ordering Part Number	CPU	PCI/PCIe	mPCIe	LAN	COM	USB
UNO-3283G	Standard	UNO-3283G-634AE	i3-6102E	1 PCIe16 1 PCI	2	2	2
		UNO-3283G-6541AE	i5-6440EQ				
		UNO-3283G-654AE	i5-6442EQ				
	UNO-3283G-674AE	i7-6822EQ					
	Non-Audio	UNO-3283G-634AO	i3-6102E				
		UNO-3283G-6541AO	i5-6440EQ				
UNO-3283G-654AO		i5-6442EQ					
UNO-3285G	Standard	UNO-3285G-634AE	i3-6102E	2 PCIe8 2 PCI	2	2	2
		UNO-3285G-654AE	i5-6440EQ				
		UNO-3285G-674AE	i7-6822EQ				
	Non-Audio	UNO-3285G-634AO	i3-6102E				
		UNO-3285G-654AO	i5-6440EQ				
		UNO-3285G-674AO	i7-6822EQ				

Optional Expansion Type

P/N	Support Model	Expansion Type
9893U20500E	UNO-3285G	4 x PCI slot
9893U20700E	UNO-3283G	2 x PCI slot
9893U20800E	UNO-3283G	2 x PCIe8 slot

iDoor Modules

- **PCM-24R2PE-AE** Intel i350, GbE, PoE IEEE 802.3af, PD, RJ45 x 2
- **PCM-24S2WF-CE** 802.11 a/b/g/n/ac 2T2R w/BT4.1, Intel AC9260
- **PCM-24D2R4-BE** 2-Ports Isolated RS-422/485 mPCIe, DB9
- **PCM-24D2R2-BE** 2-Ports Isolated RS-232 mPCIe, DB9
- **PCM-24D4R4-BE** 4-Ports Non-Isolated RS-422/485 mPCIe, DB37
- **PCM-24D4R2-BE** 4-Ports Non-Isolated RS-232 mPCIe, DB37
- **PCM-27D24DI-AE** 24-Channels Isolated Digital I/O with counter mPCIe, DB37
- **PCM-24R1TP-BE** Intel I225, 2.5Gb/s, IEEE 1588, TSN, RJ45*1

Please contact Advantech for all compatible iDoor lists

Optional Accessories

- **96PSA-A150W24T2-4** A/D 100-240V 150W 24V W/PFC C14 TERMINAL 62368
- **UNO-3283EM-AE** Extra 2 x COM ports extension kit
- **UNO-3283PR-AE** Remote Power & Reset extension kit
- **9893UH04000** Trusted Platform Module 2.0 (support from BIOS v1.17)
- **1702002600** Power Cable US Plug 1.8 M
- **1702002605** Power Cable EU Plug 1.8 M
- **1702031801** Power Cable UK Plug 1.8 M
- **1700000596** Power Cable China/Australia Plug 1.8 M
- **1700029839-01** 4-pin to 4-pin power cable for PCI/PCIe card. (5V&12V)
- **1700024858-01** 2x2 pin to 2x2 pin power cable for PCI/PCIe card. (12V&12V)

Embedded O/S

- **20703WE7PS0024** Img WS7P x86 MUI V4.19 B009 for UNO-328xG
- **20704WX1HS0016** WIN10 LTSC V6.08 for i7 version (High End)
- **20704WX1VS0016** WIN10 LTSC V6.08 for i5/i3 version (Value)
- **20703LEB1S0113** Image AdvLinuxTu V2.1.3(Ubuntu 18.04)
- **20704U20DS0005** Image AdvLinuxTu V3.2.2(Ubuntu 20.04)
- **2070014706** Img WES7P x64 MUI V4.14 B002 for UNO-328Xg

Tento produkt můžete zakoupit u společnosti AutoCont IPC a.s.



AutoCont IPC a.s.

Váš dodavatel průmyslových počítačů, komponent a speciálních průmyslových IT systémů.

 Uhlířská 1064/3, 710 00 Ostrava, Česká republika

 obchod@autocont-ipc.cz

 +420 552 301 002

 www.autocont-ipc.cz



PRŮMYSLOVÉ POČÍTAČE

fanless embedded PC, do racku, ...



POČÍTAČE S DISPLEJEM

panelové PC, terminály, do vozidel, ...



AUTOMATIZACE A SBĚR DAT

převodníky, karty, moduly, switche, ...



PERIFERIE A KOMPONENTY

monitory, klávesnice, desky, skříně, ...



NOTEBOOKY A TABLETY

odolné, windows, android, IP65, ...



INFORMAČNÍ KIOSKY

interiérové, venkovní, ...



MEDICÍNSKÁ TECHNIKA

počítače, tablety, LCD, klávesnice, ...



SOFTWAREVÁ ŘEŠENÍ

pro výrobu, zaměstnance, kiosky, ...



PŘEJÍT DO E-SHOPU

eshop.autocont-ipc.cz



DOPRAVA ZDARMA

Doprava zdarma v ČR a SR při objednávce nad 10 000 Kč bez DPH nebo nad 400 EUR.



PRODLOUŽENÁ ZÁRUKA

Záruka 2 roky na vyráběné počítače s možností jejího prodloužení až na 5 let.



ODMĚNA ZA VĚRNOST

Pravidelní zákazníci u nás nakupují za nižší ceny. Výše slevy se odvíjí od realizovaného obrátu.



SERVIS ON-SITE A IN-TIME

K projektovým dodávkám nabízíme rozšířenou podporu a servis s garancí výměny zařízení do 48 hodin.