

# UNO-238 V2

## Compact IoT Edge Computer with Intel® Core™ i Processor

NEW



### Features

- 12th Gen Intel® Core™ i Processor (up to 10 cores)
- Dual Channel DDR5-4800 up to 64GB
- M.2 E-Key, B-Key, M-Key (supports NVMe) expansion for storage/wireless
- Equipped with CANBus for reliable communication
- DC-in terminal block for wiring flexibility
- Supports multiple displays for ThinManager solution
- Supports software APIs, DeviceOn

### Specifications

#### General

- **Certification** CE, FCC Class A, UL, CCC, BSMI
- **Dimensions (W x D x H)** 150 x 107 x 60 mm (5.91 x 4.22 x 2.36 in)
- **Form Factor** Small
- **Enclosure** Aluminum housing
- **Mount Options** Stand, DIN-rail (optional)
- **Weight (Net)** 1.8 kg (3.9 lb)
- **Power Requirement** 12-24V<sub>DC</sub>
- **Power Consumption** 30-60W
- **OS Support** Windows 10 2021 LTSC, Windows 11, AdvLinux (Ubuntu 22.04)

#### System Hardware

- **BIOS** AMI EFI (256 Mbit)
- **Watchdog Timer** Programmable timer with 255 intervals (1 ~ 255 sec)
- **TPM** TPM 2.0
- **Processor** Intel® i7-1265UE (10 cores), 1.7 GHz (up to 4.7 GHz)  
Intel® i5-1245UE (10 cores), 1.5 GHz (up to 4.4 GHz)  
Intel® i3-1215UE (6 cores), 1.2 GHz (up to 4.4 GHz)
- **Memory** 2 slots for DDR5 4800 (up to 64 GB max.)  
\*Be sure to select thermal pad for CPU/RAM for RAM capacity expansion
- **Graphics Engine** Intel® Iris Xe® Graphics
- **Ethernet** LAN A: Intel® i226-LM, 10/100/1000/2500Mbps  
LAN B: Intel® i219-LM, 10/100/1000Mbps
- **LED Indicators** Power only
- **Storage** 1 x M.2 B-Key 2242 (PCIe x1/SATA, USB 2.0)  
1 x M.2 M-Key 2280 (PCIe x4, Gen 4 NVMe)
- **Expansion** 1 x M.2 B-Key 3042/3052 for LTE module (PCIe x1/SATA, USB 2.0)  
1 x M.2 E-Key 2230 for Wifi module (PCIe x1, USB 2.0)
- **SIM Slot** Yes (1 x Nano size shared with M.2 B-key 3042)

#### I/O

- **Serial Ports** 2 x RS-232/422/485 (50 to 115.2 Kbps)
- **CANBus** 2 x CAN2.0 (Combo)
- **LAN** 2 x RJ-45
- **USB** - 4 x USB 3.2 (Gen2 10Gbps)  
- 2 x USB Type-C (USB4 with USB Type-C, Bandwidth min 20Gbps, max 40Gbps, with USB3.2, Display & PCIe)
- **Displays** 1 x HDMI 2.0 (up to 4096 x 2160 @60 Hz)  
1 x DP 1.4a (up to 4096 x 2304 @60 Hz)
- **Power Connector** 1 x Terminal block
- **Others** 1 x GPIO (Default 8DI)

#### Environment

- **Operating Temperature** 0 ~ 50 °C with 0.7 m/s airflow  
-20 ~ 60 °C with 0.7 m/s airflow  
(With extended temperature peripherals, please refer to the optional memory list on page 3)
- **Storage Temperature** -40 ~ 85 °C / -40 ~ 185 °F
- **Relative Humidity** Operating, 95% RH @ 40°C, non-condensing  
Non-operating, 95%RH @ 60°C, non-condensing
- **Shock Protection** Operating, IEC 60068-2-27, 50G, half sine, 11 ms
- **Vibration Protection** Operating, IEC 60068-2-64, 2 Grms, random, 5 ~ 500 Hz, 1hr/axis

## Installation Scenario

### Wall/Stand Mount

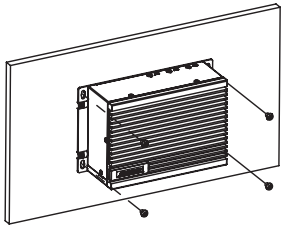

Wall Mount

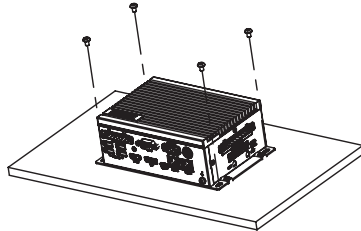

Stand Mount

### DIN-Rail Mount (with optional DIN-rail kit)

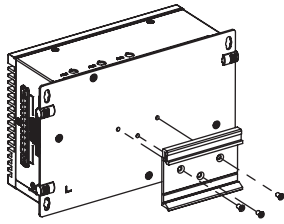

DIN-Rail Assembly

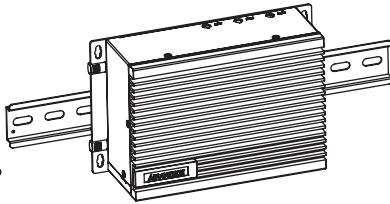

DIN-Rail Installation

## Thermal Pad for DDR5

Schematic Diagram	Specification (DDR5)	P/N & Location of Thermal Pad	
	RAM 8/16G	Up	1990026727N030
		Down	1990040197N020
	RAM 32G	Up	1990026727N010
		Down	1990040197N000

## Dimensions

Unit: mm

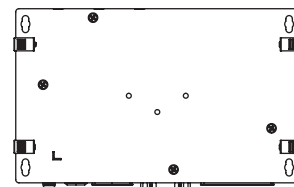
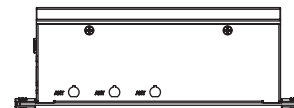
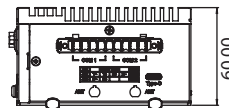
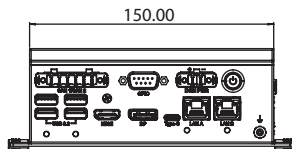
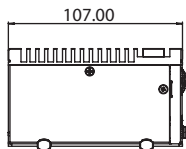
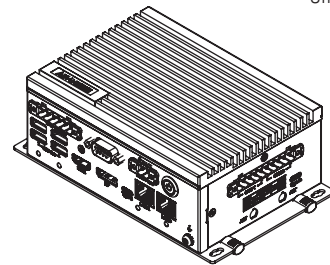
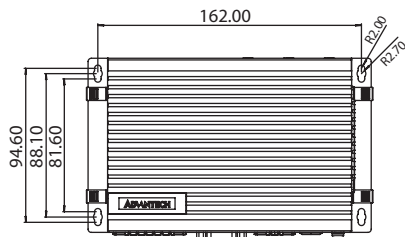

### Front I/O

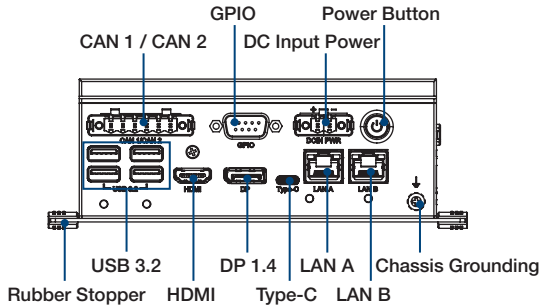

### Right I/O

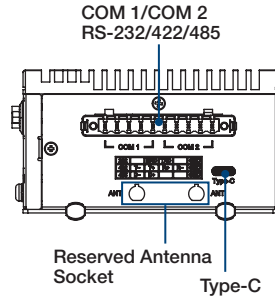

### Rear I/O

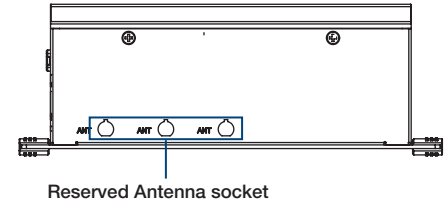

## Ordering Information

Part Number	CPU	Max. Frequency	Cores	Storage	COM	CAN	USB	Display	GPIO	TPM
UNO-238-C3N1AE	i3-1215UE	4.40 GHz	6	M.2 B-/M-Key	RS-232/422/485 x2	Y	USB 3.2 x4 Type-C x2	DP/HDMI x1	Y	Y
UNO-238-C5N1AE	i5-1245UE	4.40 GHz	10							
UNO-238-C7N1AE	i7-1265UE	4.70 GHz	10							

## Suggested Memory List

Capacity	Temp.	P/N
8G	0 ~ 85 °C	SQR-SD5N8G4K8SNGBB
		SQR-SD5N8G4K8MNGAB
16G	0 ~ 85 °C	SQR-SD5N16G4K8SNBB
		SQR-SD5N16G4K8MNAB
	-40 ~ 85 °C	SQR-SD5I16G4K8SNBB
32G	0 ~ 85 °C	SQR-SD5N32G4K8SNBB
		SQR-SD5N32G4K8MNAB
	-40 ~ 85 °C	SQR-SD5I32G4K8SNBB

## Packing list

Items	P/N
A/D 100-240V 84W 12V C14 TERMINAL BLOCK 2P	XUNO-FSP084-DHAN3

\*For customer who need ErP support can choose this 12V adapter

## Suggested M.2 SATA SSD List

Capacity	Type	Interface	Length	Temp.		P/N
				0-70 °C	-20-85 °C	
64G	M.2 B+M-Key	SATA	2242	0-70 °C	-20-85 °C	SQF-S4BV1-64GSDSDC
				0-70 °C	-20-85 °C	SQF-S4BV2-64GSDSDM
128G	M.2 B+M-Key	SATA	2242	0-70 °C	-20-85 °C	SQF-S4BV2-128GSDSDC
				0-70 °C	-20-85 °C	SQF-S4BV2-128GSDSDM
	M.2 M-Key	PCIe/NVMe	2280	0-70 °C	-20-85 °C	SQF-C8MV2-128GDEDC
				0-70 °C	-20-85 °C	SQF-C8MV2-128GDEDM
256G	M.2 B+M-Key	SATA	2242	0-70 °C	-20-85 °C	SQF-S4BV2-256GSDSDC
				0-70 °C	-20-85 °C	SQF-S4BV2-256GSDSDM
	M.2 M-Key	PCIe/NVMe	2280	0-70 °C	-20-85 °C	SQF-C8MV2-256GDEDC
				0-70 °C	-20-85 °C	SQF-C8MV2-256GDEDM
512G	M.2 B+M-Key	SATA	2242	0-70 °C	-20-85 °C	SQF-S4BV2-512GSDSDC
				0-70 °C	-20-85 °C	SQF-S4BV2-512GSDSDM
	M.2 M-Key	PCIe/NVMe	2280	0-70 °C	-20-85 °C	SQF-C8MV2-512GDEDC
				0-70 °C	-20-85 °C	SQF-C8MV2-512GDEDM
1TB	M.2 B+M-Key	SATA	2242	0-70 °C	-20-85 °C	SQF-S4BV2-1TDSDC
				0-70 °C	-20-85 °C	SQF-S4BV2-1TDSM
	M.2 M-Key	PCIe/NVMe	2280	0-70 °C	-20-85 °C	SQF-C8MV4-1TDEDC
				0-70 °C	-20-85 °C	SQF-C8MV4-1TDEDM

\*The operating environment should be less than 55°C if use SSD larger than 1TB

\*Be sure to select thermal pad for CPU/RAM for RAM capacity expansion

Please note: If some optional modules are offered with the system, additional system certificates may be required in certain regions/countries. Please contact Advantech for certificate compliance.

## Embedded Image

- 20701WX1HS0000     Img WIN10 LTSC x64 v6.08 b052 UNO-238\_V2 High for i7 version
- 20701WX1VS0000     Img WIN10 LTSC x64 v6.08 b052 UNO-238\_V2 Value for i3/i5 version
- 20701U22DS0000     Image AdvLinuxTu-IOTG\_x64 V4.0.3 for UNO series

## Optional Accessories

- 1702002600     Power cable US plug, 1.8 M (industrial grade)
- 1702002605     Power cable EU plug, 1.8 M (industrial grade)
- 1702031801     Power cable UK plug, 1.8 M (industrial grade)
- UNO-200-DMKBE     UNO-238 V2 Din-rail kit
- UNO-2000G-VMKAE     UNO & FPM integration VESA Mount kit
- 1990026727N030     Thermal Pad for upside DDR5 (8G/16G)
- 1990040197N020     Thermal Pad for downside DDR5 (8G/16G)
- 1990026727N010     Thermal Pad for upside DDR5 (32G)
- 1990040197N000     Thermal Pad for downside DDR5 (32G)
- 1990040412N000     Thermal Pad for M.2 M key 2280 NVME 1T SSD
- 1990040776N000     Thermal Pad for CPU
- 1990040198N000     M.2 B Key 3042/3052 (LTE)

# Tento produkt můžete zakoupit u společnosti AutoCont IPC a.s.



## AutoCont IPC a.s.

Váš dodavatel průmyslových počítačů, komponent a speciálních průmyslových IT systémů.

 Uhlířská 1064/3, 710 00 Ostrava, Česká republika

 obchod@autocont-ipc.cz

 +420 552 301 002

 [www.autocont-ipc.cz](http://www.autocont-ipc.cz)



### PRŮMYSLOVÉ POČÍTAČE

*fanless embedded PC, do racku, ...*



### POČÍTAČE S DISPLEJEM

*panelové PC, terminály, do vozidel, ...*



### AUTOMATIZACE A SBĚR DAT

*převodníky, karty, moduly, switche, ...*



### PERIFERIE A KOMPONENTY

*monitory, klávesnice, desky, skříně, ...*



### NOTEBOOKY A TABLETY

*odolné, windows, android, IP65, ...*



### INFORMAČNÍ KIOSKY

*interiérové, venkovní, ...*



### MEDICÍNSKÁ TECHNIKA

*počítače, tablety, LCD, klávesnice, ...*



### SOFTWAREVÁ ŘEŠENÍ

*pro výrobu, zaměstnance, kiosky, ...*



### PŘEJÍT DO E-SHOPU

[eshop.autocont-ipc.cz](http://eshop.autocont-ipc.cz)



### DOPRAVA ZDARMA

Doprava zdarma v ČR a SR při objednávce nad 10 000 Kč bez DPH nebo nad 400 EUR.



### PRODLOUŽENÁ ZÁRUKA

Záruka 2 roky na vyráběné počítače s možností jejího prodloužení až na 5 let.



### ODMĚNA ZA VĚRNOST

Pravidelní zákazníci u nás nakupují za nižší ceny. Výše slevy se odvíjí od realizovaného obrátu.



### SERVIS ON-SITE A IN-TIME

K projektovým dodávkám nabízíme rozšířenou podporu a servis s garancí výměny zařízení do 48 hodin.