

TPC-100W

7"/10.1"/15.6"/21.5" Touch Panel Computer with ARM Cortex™-A53 Processor

NEW



Introduction

TPC-100W series is a compact touch panel computer equipped with an NXP® Cortex™-A53 i.MX 8M Mini quad-core processor, 7"/10.1"/15.6"/21.5" TFT LCD display, multi-touch glass sensor, 4 GB of DDR4 RAM, and 16 GB of eMMC storage. To ensure stable operation in harsh industrial environments, TPC-100W supports a wide operating temperature range (-20 ~ 60 °C / -4 ~ 140 °F) and Panel/VESA mounting and features an IP66-rated front panel that protects against water and dust ingress.

For web-based operations, TPC-100W offers two 10/100/1000 LANs that one supports the IEEE 802.3 at PoE-PD standard. The inclusion of VNC and browsers enable rapid Web application development and easy configuration. Finally, TPC-100W supports various OS including Linux Yocto with full QT graphics and Android to ensure easy deployment for diverse applications.

Specifications

General

- **Certification** CE, BSMI, CCC, UL, FCC Class A
- **Dimensions (W x H x D)**
 - TPC-107W: 205 x 146.92 x 52 mm
 - TPC-110W: 283.1 x 202.3 x 52 mm
 - TPC-115W: 419.7 x 269 x 52 mm
 - TPC-121W: 558.4 x 349.8 x 52 mm
- **Cutout Dimensions**
 - TPC-107W: 192.4 x 139.0 mm
 - TPC-110W: 274.1 x 193.3 mm
 - TPC-115W: 411.9 x 261.2 mm
 - TPC-121W: 549.8 x 341.3 mm
- **OS Support** Linux Yocto 3.3, Android 10
- **Power Input** 24V_{DC} ±20
- **Power Consumption** 9W (typ.); 21W (max.)
- **Unit Enclosure** Die-cast aluminum alloy front bezel
Metal Shell
- **Mount Options** Panel and VESA
- **Weight (Net)**
 - 7": 2kg (4.44lb)
 - 10.1": 3.9kg (8.63lb)
 - 15.6": 4.1 kg (9.03lb)
 - 21.5": 6.1 kg (13.45lb)

System Kernel

- **CPU** NXP® ARM® Cortex™-A53 i.MX 8M Mini quad-core
1.6 GHz processor
FRAM 1 MB
- **Backup Memory** FRAM 1 MB
- **Memory** Quad core: 4 GB of DDR4 RAM
- **Storage** 16 GB eMMC onboard

Communication Interface

- **Serial Port** 1 x RS-232/422/485 (COM 1)
1 x selectable mode for RS-485 and CAN 2.0B (COM 2)
- **LAN** 2 x RJ45 (10/100/1000 Mbps)
Optional module is required to support PoE PD (LAN A)
IEEE802.3at PoE-PD standard
- **Others** 1 x USB 2.0 Type-B Client (Internal)
2 x USB 2.0 Type-A Host
1 x Micro SD (Internal)
1 x M.2 Key-E 2230 (Wi-Fi/BT)

*PoE-PD is not supported on TPC-115W and TPC-121W

Features

- NXP® ARM® Cortex™-A53 i.MX 8M Mini quad-core processor
- 7", 10.1", 15.6" and 21.5" 16:9 LCD with multi-touch P-CAP and true-flat IP66-rated front panel
- Built in 4 GB DDR4 RAM and 16 GB eMMC storage onboard
- 2 x 10/100/1000 Mbps LANs with optional IEEE 802.3at/af PoE-PD module support (7" and 10.1" only)
- 1 mb FRAM backup memory for unexpected power interruptions
- 2 x Serial port with 120Ω termination resistor that one supports the CAN 2.0B protocol and offers a programmable bit rate of up to 1 Mb/sec
- Embedded browser and for rapid Web App development
- Supports Linux Yocto and Android
- Optional and mPCIe expansion modules
- Compatible with VESA and panel mounting
- Wide operating temperature range (-20 ~ 60 °C/-4 ~ 140 °F)

LCD Panel

	TPC-107W	TPC-110W	TPC-115W	TPC-121W
Panel Size	7"	10.1"	15.6"	21.5"
Panel Type	WSVGA TFT LCD	WXGA TFT LCD	FHD TFT LCD	FHD TFT LCD
Aspect Ratio	16:9	16:10	16:9	16:9
Max. Resolution	1024 x 600	1280 x 800	1920 x 1080	1920 x 1080
Max. Colors	16M	16M	16.2M	16.7M
Luminance (nits)	425	500	450	250
Viewing Angle (H/V)	170/170	170/170	170/170	89/89
Backlight Life	50000	50000	50000	50000
Treatment	Anti-glare	Anti-glare	Anti-glare	Anti-glare
Contrast Ratio	800:1	800:1	800:1	1000:1
LED Indicator	Yes	Yes	Yes	Yes

Touchscreen

- **Touch Points** 10 Points
- **Light** Transmission above 85%
- **Pencil Hardness** ≥7H
- **Type** Projected capacitive (P-CAP) touch

Environment

- **Operating Temperature** -20 ~ 60 °C (-4 ~ 140 °F)
- **Storage Temperature** -30 ~ 70 °C (-22 ~ 158 °F)
- **Humidity** 95% RH @ 40 °C, non-condensing
- **Ingress Protection** IP66-rated front panel
- **Vibration Protection** 2 Grms random vibration (5 ~ 500 Hz) during operation (compliant with IEC60068-2-64)
- **Shock Protection** 10 G shock under 11 ms operation (compliant with IEC60068-2-27)

Dimensions

Unit: mm

TPC-107W

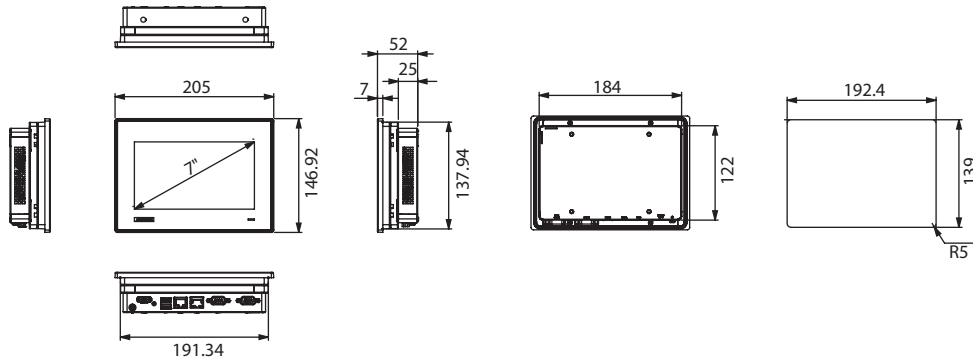

Panel Cutout Dimensions: 192.4mm x 139.0mm

TPC-110W

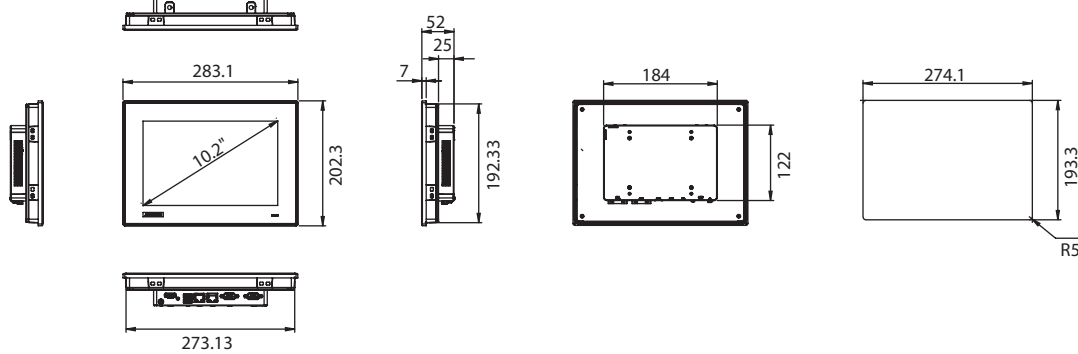

Panel Cutout Dimensions: 274.1mm x 193.3mm

TPC-115W

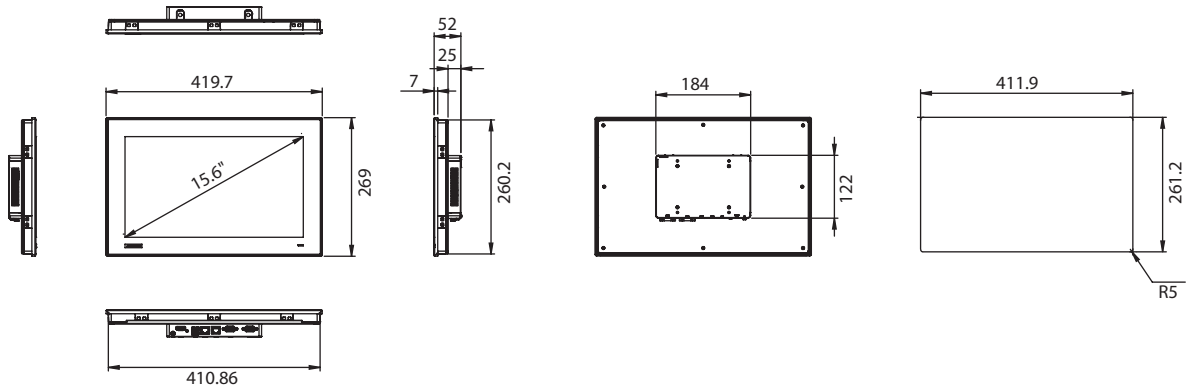

Panel Cutout Dimensions: 411.9mm x 261.2mm

Dimensions

Unit: mm

TPC-121W

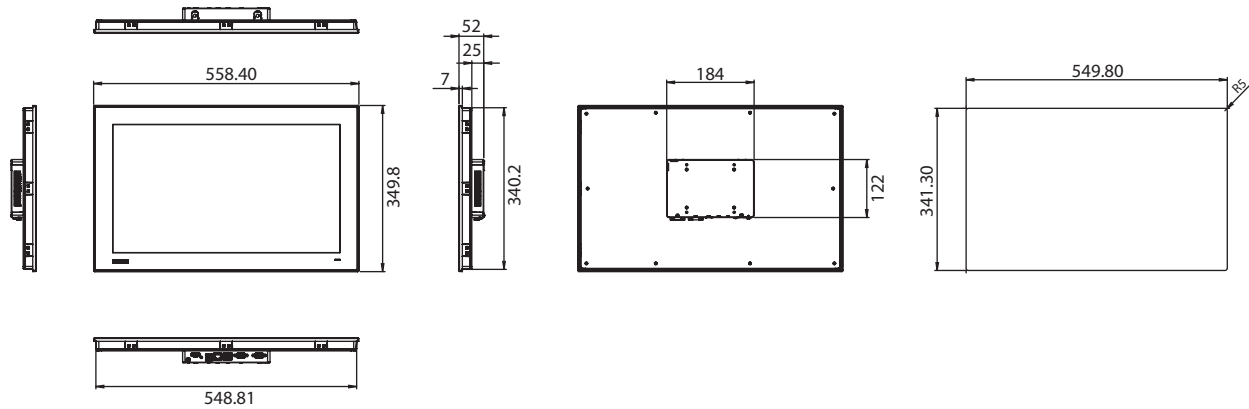

Panel Cutout Dimensions: 549.8 x 341.3 mm

Ordering Information

- **TPC-107W-N32YB** 7" i.MX8M Mini Quad,4GB RAM,16GB eMMC, w/CAN, Yocto
- **TPC-107W-N32AB** 7" i.MX8M Mini Quad,4GB RAM,16GB eMMC, w/CAN, Android
- **TPC-110W-N32YB** 10.1" i.MX8M Mini Quad,4GB RAM,16GB eMMC, w/CAN, Yocto
- **TPC-110W-N32AB** 10.1" i.MX8M Mini Quad,4GB RAM,16GB eMMC, w/CAN, Android
- **TPC-115W-N32YB** 15" FHD,i.MX8M Mini Quad, 4GB RAM,16GB eMMC, w/CAN, Yocto
- **TPC-115W-N32AB** 15" FHD,i.MX8M Mini Quad, 4GB RAM,16GB eMMC, w/CAN, Android
- **TPC-121W-N32YB** 21.5" FHD,i.MX8M Mini Quad,4GB RAM,16GB eMMC, w/CAN, Yocto
- **TPC-121W-N32AB** 21.5" FHD,i.MX8M Mini Quad,4GB RAM,16GB eMMC, w/CAN, Android

Optional Accessories

- **96PSA-A60W24T2-3** Adaptor A/D 100 – 240V 60W 24V C14 cord-end terminal
- **1702002600** Power cable with US plug, 1.8 M
- **1702002605** Power cable with EU plug, 1.8 M
- **1702031801** Power cable with UK plug, 1.8 M
- **1702031836** Power cable with China/Australia plug, 1.8 M
- **98R4T100W01** Economic package for TPC-100W, WiFi/Bluetooth KIT
- **98R4T100W00** TPC-100W, PoE Module (7" and 10.1" only)

PoE Module Expansion

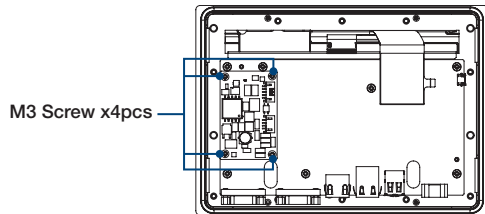

External I/O

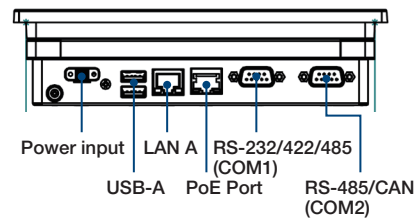
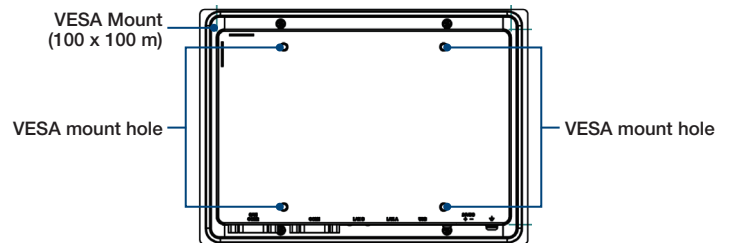
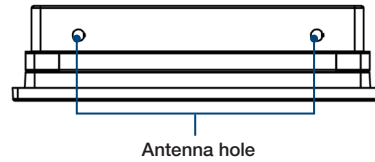

Packing List

Item	Part No.	Depiction	TPC-107W	TPC-110W	TPC-115W	TPC-121W
			Qty	Qty	Qty	Qty
Lock Cable	1990026085S000	WC LOCKINE CABLE 62x8mm WL3-60T For SCH	2	2	2	2
Plug-In Block	1652002209	PLUG-IN BLOCKDIP 2P(F)	1	1	1	1
Cable	1703011001-11	A Cable G-TEM 4.3 100CM C=GR/Y	1	1	1	1
Clamp	1962055040	CLAMPER PPC-55 M1632611 A2	4	8	10	12
Clamp Screw	1935042520	Screw M4x25L R/S D=8.3 H=2.5 (2+) ST BZn	4	8	10	12

Please note: If some optional modules are offered with the system, additional system certificates may be required in certain regions/countries. Please contact Advantech for certificate compliance.

Tento produkt můžete zakoupit u společnosti AutoCont IPC a.s.



AutoCont IPC a.s.

Váš dodavatel průmyslových počítačů, komponent a speciálních průmyslových IT systémů.

 Uhlířská 1064/3, 710 00 Ostrava, Česká republika

 obchod@autocont-ipc.cz

 +420 552 301 002

 www.autocont-ipc.cz



PRŮMYSLOVÉ POČÍTAČE

fanless embedded PC, do racku, ...



POČÍTAČE S DISPLEJEM

panelové PC, terminály, do vozidel, ...



AUTOMATIZACE A SBĚR DAT

převodníky, karty, moduly, switche, ...



PERIFERIE A KOMPONENTY

monitory, klávesnice, desky, skříně, ...



NOTEBOOKY A TABLETY

odolné, windows, android, IP65, ...



INFORMAČNÍ KIOSKY

interiérové, venkovní, ...



MEDICÍNSKÁ TECHNIKA

počítače, tablety, LCD, klávesnice, ...



SOFTWAREVÁ ŘEŠENÍ

pro výrobu, zaměstnance, kiosky, ...



PŘEJÍT DO E-SHOPU

eshop.autocont-ipc.cz



DOPRAVA ZDARMA

Doprava zdarma v ČR a SR při objednávce nad 10 000 Kč bez DPH nebo nad 400 EUR.



PRODLOUŽENÁ ZÁRUKA

Záruka 2 roky na vyráběné počítače s možností jejího prodloužení až na 5 let.



ODMĚNA ZA VĚRNOST

Pravidelní zákazníci u nás nakupují za nižší ceny. Výše slevy se odvíjí od realizovaného obrátu.



SERVIS ON-SITE A IN-TIME

K projektovým dodávkám nabízíme rozšířenou podporu a servis s garancí výměny zařízení do 48 hodin.