

Industrial Cellular Routers & Gateways

ICR-2701

Industrial Wired Router & IoT Gateway



- 1.3 GB eMMC storage to host customer SW applications
- 2× Ethernet 10/100
- Optional WiFi 802.11n
- USB Host 2.0
- Optional Metal or Plastic case
- DIN Rail mounting
- Wide operational temperature range
- Backup real time clock
- Sleep mode

Project based customization: Last-gasp Supercapacitor, TPM 2.0

Introduction



ICR-2701 is enhanced successor of the Advantech's LAN router platform v2 that was originally introduced in 2010. Ruggedized for industrial use keeping the same dimensions, configuration possibilities and full operating system compatibility with Advantech cellular routers including support of software platforms WebAccess/VPN and WebAccess/DMP.

ICR-2701 offers more powerful CPU and ample of data storage to ensure long lifecycle (software updates) with broad software customization possibilities for user. On project-based agreement, we can optionally add a TPM 2.0 chip (Trusted Platform Module) onboard verifying router integrity to provide trusted solution as a response to increasing cybersecurity demands in many industrial and public sectors. LAN router ICR-2701 is equipped with 2× Ethernet 10/100 ports with two independent LANs/IP addresses and 1× USB 2.0 host port. Optional built-in WiFi 802.11 ac,a,b,g,n with AP, Client and Multirole modes are available.

The router is powered by well-known Linux based Advantech's operating system ICR-OS. A secure web interface allows users to configure and manage ICR-2701 from remote locations. ICR-2701 supports real-time data encryption and establishing of VPN tunnels using IPsec, WireGuard, OpenVPN, GRE, etc. It supports standard and advanced networking features like DHCP, NAT, NAT-T, DynDNS, NTP, VRRP, and numerous other functions.

The 1.3 GB eMMC available storage for customer with an open Linux platform and the wide possibility of programming customer SW applications in Python and C/C++ ICR-2701 offers a real open development platform for Industrial IoT applications. Advantech existing Router App library (User modules) with apps already developed to enhance specific router functionalities includes industrial protocol conversions, dynamic protocols and support of IoT platforms such as MS Azure, Cumulocity, and others.

ICR-2701 is easy to install individually and in mass deployments scenarios too by using a full-featured configuration and monitoring software tool WebAccess/DMP. Safe remote VPN access to customer devices and PC's connected to routers through Internet can be administrated by additional software WebAccess/VPN.













Using ICR-2701 in industrial and non-industrial environment bringing the key advantage in full compatibility with Advantech cellular routers where complete communication structure is unified and the same procedures and tools can be used for cellular and non-cellular part of the application as well. LAN routers are frequently used as secure LAN to WAN gateways and VPN appliances in a large scope of monitoring and data acquisition systems.



WebAccess/DMP WebAccess/VPN



Order Codes

Model no. - Order Codes	REGION	2× Ethernet 10/100 Mbps	WiFi	1× USB Host 2.0	Metal Case	Plastic Case	Accessories
 ICR-2701	GLOBAL	✓		✓	✓		
 ICR-2701P	GLOBAL	✓		✓		✓	
 ICR-2701A01	GLOBAL	✓		✓	✓		✓ EU Power Supply
 ICR-2701PA01	GLOBAL	✓		✓		✓	✓ EU Power Supply
 ICR-2701A02	GLOBAL	✓		✓	✓		✓ UK Power Supply
 ICR-2701PA02	GLOBAL	✓		✓		✓	✓ UK Power Supply
 ICR-2701W	GLOBAL	✓	✓	✓	✓		
 ICR-2701WP	GLOBAL	✓	✓	✓		✓	
 ICR-2701WA01	GLOBAL	✓	✓	✓	✓		✓ EU Power Supply
 ICR-2701WPA01	GLOBAL	✓	✓	✓		✓	✓ EU Power Supply
 ICR-2701WA02	GLOBAL	✓	✓	✓	✓		✓ UK Power Supply
 ICR-2701WPA02	GLOBAL	✓	✓	✓		✓	✓ UK Power Supply

Specifications

System	
CPU	ARM926EJ-S, 600 MHz
Memory	RAM - 128 MB eMMC - 4096 MB (838 MB for Router Apps, 512 MB for customer data)
Watchdog	HW Watchdog
RTC	Battery backup RTC
TPM*	Trusted Platform Module (TPM) 2.0
Supercap*	Last-gasp Supercapacitor
Interfaces	
Ethernet	2x Ethernet, RJ45, 10/100 Mbps, Isolation 1.5 kV
USB	1x USB 2.0 Host Connector
Reset Button	Reboot / Factory reset
LED Indicators	System, ETH

* Project based customization

Environmental	
Power Supply	9 – 48 V DC (2-pin terminal block)
Consumption	Idle 1.8 W / Average 1.9 W / Maximum 5.8 W
Sleep Mode	Yes, 3 mW
Operating Temperature	-40 to +75 °C
Storage Temperature	-40 to +85 °C
Humidity	5 to 95 %
IP Cover	IP30
Physical Characteristics	
Dimensions (without DIN holder)	Metal Case: 42 × 80.3 × 113.2 mm Plastic Case: 51.4 × 83.8 × 117 mm
Enclosure	Metal Case with grounding screw or Plastic Case
Mounting	DIN-Rail
Weight	Metal Case: 230 g Plastic Case: 170 g

WiFi - ICR-2701Wxxxx	
Antenna	1x R-SMA connector
Standards	IEEE802.11 ac/a/b/g/n 2.4 GHz / 5 GHz
Security	WPA, WPA2, WPA3, 802.1X
Modes	Access Point (up to 8 clients), Station, Multirole STA & AP

Software	
Operating System	ICR-OS (Linux based)
SW Customization	Router App (User Modules)*
Application Development	Open Linux, *Python, BASH, C/C++
Industrial Protocols and IoT	*Modbus RTU/TCP gateway, *IEC 60870-5-101 to 104 gateway, *DF1, *DNP3, *MQTT, *LWM2M
Networking Features and Protocols	DHCP, NAT/PAT, SSH, VRRP, PPPoE, SNMP, SMTP, Dynamic DNS client, DNS proxy, VLAN, QoS, *DMVPN, NTP Client/Server, *Routing protocols RIP, BGP, OSPF, IS-IS, NHRP, Backup Routes, Port Forwarding, Host Port Routing, Ethernet Bridging, Load Balancing, IPv6 Dual Stack
Security	HTTPS, SSH, SFTP, DMZ, Firewall (IP Filtering, MAC address filtering, Inbound and outbound Port filtering) VPN Tunneling – WireGuard, OpenVPN, *EasyVPN, IPsec with IKEv1 and IKEv2, GRE, L2TP, PPTP Authentication – RADIUS, TACACS+, 2FA, *SCEP Encryption – DES, 3DES, AES, RSA, MD5, SHA
Firmware Management	Automatic firmware updates – server, locally via LAN or remotely via WAN
Diagnostic/Log	Status – Data Usage One CLICK report – Current Configuration, Factory Identification, Routing Table Log – System Log, Reboot Log, Kernel Log Remote Diagnostics (via SSH)
Event Engine	StartUp script & Up/Down script (Own rules based on Digital Inputs, Network Parameters, Data Usage, Timer, Power, Device Temperature) Report Types: *email, *SNMP Trap
Configuration	Web server, SSH, Four configuration switchable profiles, Automatic configuration update from server, Backup & Restore configuration
Advanced Software Tools	WebAccess/DMP – Remote Device Provisioning, Monitoring & Management Platform WebAccess/VPN – Advanced Secure Networking Platform

*Functionality is available with installed Router App (User Module)

Industrial Cellular Routers & Gateways

ICR-2701

Standards & Regulations	
Radio	EN 300 328, EN 301 893
EMC	EN 301 489-1, EN 301 489-17, EN 61000-4-2, EN 61000-4-3, EN 61000-4-4, EN 61000-4-5, EN 61000-4-6, EN 61000-4-11, IEC 61000-6-2, IEC 61000-6-3, EN 55032
Safety	EN 62368-1, IEEE 802.3
Transportation	E8
National	CE, UKCA
Mechanical	EN 60529, EN 60068-2-27, EN 60068-2-64
Climatic	EN 60068-2-1, EN 60068-2-2, EN 60068-2-14, EN 60068-2-30
Environmental	REACH, RoHS3, WEEE

Views

FRONT VIEWS

METAL VERSION

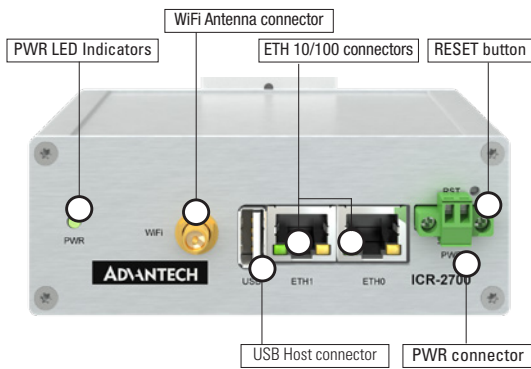

PLASTIC VERSION

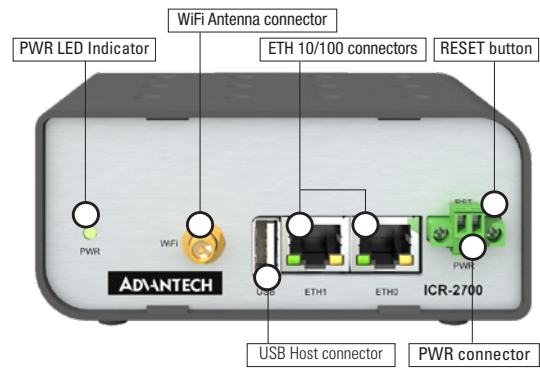

REAR VIEWS

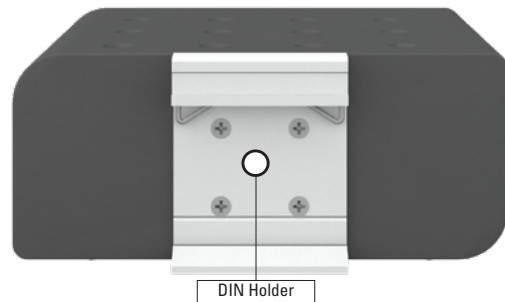
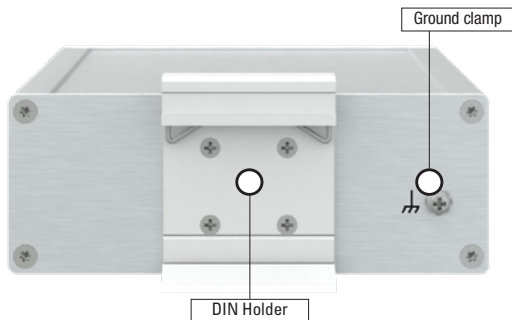

Accessories

Part Number	Description	Included in the package						Sold Separately
		ICR-2701 ICR-2701W	ICR-2701P ICR-2701WP	ICR-2701A01 ICR-2701WA01	ICR-2701PA01 ICR-2701WPA01	ICR-2701A02 ICR-2701WA02	ICR-2701PA02 ICR-2701WPA02	
BB-CON-WR2	2-pin PWR connector	✓	✓	✓	✓	✓	✓	✓
BB-SBD40	DIN clip	✓		✓		✓		✓
BB-SBD40P	DIN clip		✓		✓		✓	✓
BB-KD-ETH	Ethernet cross cable			✓	✓	✓	✓	✓
BB-RPS-v2-WR2-EU	Wall mount Power supply, 12V/1A, EU plug			✓	✓			✓
BB-RPS-v2-WR2-UK	Wall mount Power supply, 12V/1A, UK plug					✓	✓	✓
BB-RPS-v2-WR2-US	Wall mount Power supply, 12V/1A, US plug							✓
BB-AW-A2458G-FSRPK	Antenna Wi-Fi, 2.4 & 5.8 GHz	ICR-2701W	ICR-2701WP	ICR-2701WA01	ICR-2701WPA01	ICR-2701WA02	ICR-2701WPA02	✓

For more accessories (Antennas, Power Supplies) visit www.advantech.com

Dimensions - Technical Drawing

Metal version with DIN holder

Unit: mm

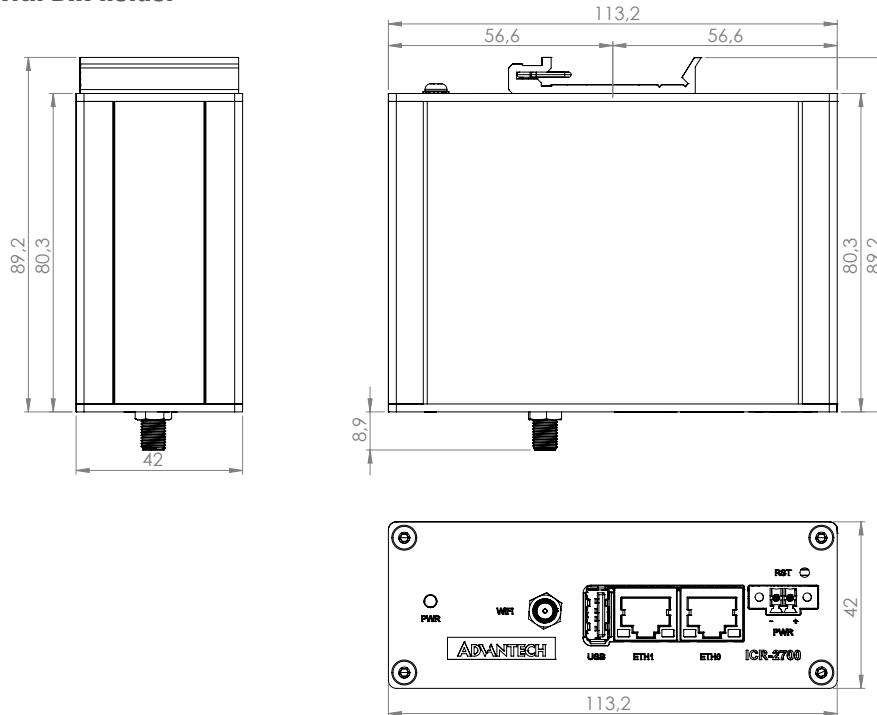

Plastic version with DIN holder

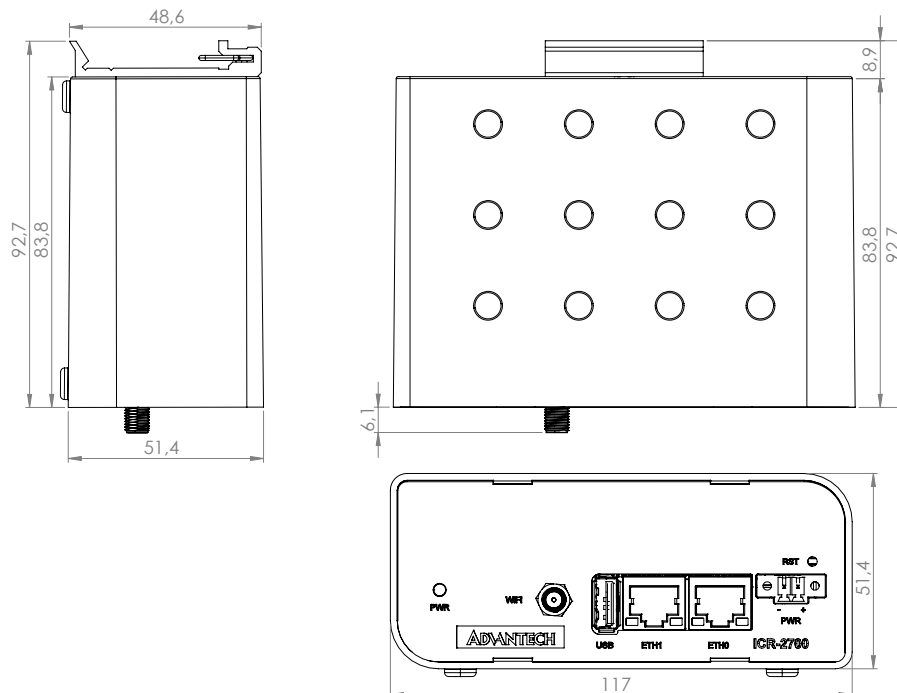

Tento produkt můžete zakoupit u společnosti AutoCont IPC a.s.



AutoCont IPC a.s.

Váš dodavatel průmyslových počítačů, komponent a speciálních průmyslových IT systémů.

 Uhlířská 1064/3, 710 00 Ostrava, Česká republika

 obchod@autocont-ipc.cz

 +420 552 301 002

 www.autocont-ipc.cz



PRŮMYSLOVÉ POČÍTAČE

fanless embedded PC, do racku, ...



POČÍTAČE S DISPLEJEM

panelové PC, terminály, do vozidel, ...



AUTOMATIZACE A SBĚR DAT

převodníky, karty, moduly, switche, ...



PERIFERIE A KOMPONENTY

monitory, klávesnice, desky, skříně, ...



NOTEBOOKY A TABLETY

odolné, windows, android, IP65, ...



INFORMAČNÍ KIOSKY

interiérové, venkovní, ...



MEDICÍNSKÁ TECHNIKA

počítače, tablety, LCD, klávesnice, ...



SOFTWAREVÁ ŘEŠENÍ

pro výrobu, zaměstnance, kiosky, ...



PŘEJÍT DO E-SHOPU

eshop.autocont-ipc.cz



DOPRAVA ZDARMA

Doprava zdarma v ČR a SR při objednávce nad 10 000 Kč bez DPH nebo nad 400 EUR.



PRODLOUŽENÁ ZÁRUKA

Záruka 2 roky na vyráběné počítače s možností jejího prodloužení až na 5 let.



ODMĚNA ZA VĚRNOST

Pravidelní zákazníci u nás nakupují za nižší ceny. Výše slevy se odvíjí od realizovaného obrátu.



SERVIS ON-SITE A IN-TIME

K projektovým dodávkám nabízíme rozšířenou podporu a servis s garancí výměny zařízení do 48 hodin.