

ICR-2531

Entry-Level 4G Router



Features

- LTE Cat.4 with 3G/2G fallback
- 2× SIM for redundancy
- 4× Ethernet 10/100 Mbps (3+1 RJ45)
- 1× DI, 1× DO
- Wide operational temperature range
- Wall and DIN mount options
- Linux based OS & SW customization
- Optional WiFi 802.11n



Introduction

Industrial cellular router ICR-2531 is designed for wireless communication in the mobile networks that make use of traditional cellular technologies. The primary purpose of this router is its use in the Category 4 (Cat.4) services on the cellular LTE network. The peak downlink data rate for a Category 4 is approximately 150 Mbps. Also in the uplink, LTE Category 4 provides a peak data rate of 50 Mbps. Optional built-in WiFi 802.11 ac,b,g,n with AP, Client and Multirole modes are available.

The router is equipped with four Ethernet ports while three are switched and one is separated. Both 3× ETH0 and 1× ETH1 ports may be independently configurable as LAN or WAN interfaces. The router supports VPN tunnel creation using various protocols to ensure safe communications. The router provides diagnostic functions which include automatic monitoring of the wireless and wired connections, automatic restart in case of connection losses, and a hardware watchdog that monitors the router status.

With open Linux platform and wide possibilities of programming customer SW applications in Python, C/C++. The Advantech existing app library Router Apps (User modules) with apps already developed to enhance specific router functionality including industrial protocol conversions and support of IoT platforms such as MS Azure, Cumulocity, ThingWorx, and others are supported on the router.





WebAccess/VPN



WebAccess/DMP



Model no. - Order Codes	REGION	4× Ethernet 10/100 Mbps	I/O	1× ANT 1× DIV	2× SIM	WiFi
 ICR-2531	EMEA	✓	✓	✓	✓	
 ICR-2531W	EMEA	✓	✓	✓	✓	✓

Specifications

System	
CPU	ARM926EJ-S, 600 MHz
Memory	RAM - 128 MB NOR Flash - 64 MB (12 MB for Router Apps, 2 MB for customer data)
Watchdog	HW Watchdog
RTC	Battery backup RTC
Interfaces	
Ethernet	4x Ethernet (3+1), RJ45, 10/100 Mbps, 1.5 kV
I / O	1x Digital Input (36V/0.5 mA) 1x Digital Output (Open Drain, 36 V/ 100 mA) (6-pin terminal block together with PWR)
Reset Button	Reboot / Factory reset
LED Indicators	System, Signal strength, Data activity, SIM1/SIM2 status, 2G/3G/4G technology, Input, Output, User, ETH

Environmental	
Power Supply	9 – 48 V DC (6-pin terminal block together with I/O)
Consumption	ICR-2531: Idle 2.6 W / Average 3.6 W / Maximum 5.4 W ICR-2531W: Idle 2.9 W / Average 4.2 W / Maximum 6.1 W
Operating Temperature	-40 to +75 °C
Storage Temperature	-40 to +85 °C
Humidity	5 to 95 % , non-condensing
IP Cover	IP30
Physical Characteristics	
Dimensions	130 mm x 95 mm x 25 mm
Enclosure	Metal Case, Grounding Screw
Mounting	Wall mount, * Optional DIN Rail mount
Weight	375 g

WiFi - ICR-2531W	
Antenna	1x R-SMA connector
Standards	IEEE802.11 ac/a/b/g/n 2.4 GHz / 5 GHz
Security	WEP, TKIP, AES, WPA, WPA2, WPA3, 802.1X
Modes	Access Point (up to 8 clients), Station, Multirole STA & AP

Cellular Interface	
SIM Slots	2x SIM (Micro SIM – 3FF)
Antennas	2x SMA connector (1x Main, 1x Diversity)
LTE Parameters	Supported FDD frequencies: B1 (2100 MHz), B3 (1800 MHz), B7 (2600 MHz), B8 (900 MHz), B20 (800 MHz), B28A (700 MHz) Supported TDD frequencies: B38 (2600 MHz), B40 (2300 MHz), B41 (2500 MHz) Transfer rate: 150 Mbps (DL), 50 Mbps (UL)
HSPA+/UMTS Parameters	Supported frequencies: B1 (2100 MHz), B8 (900 MHz) Transfer rate: 42 Mbps (DL), 5.76 Mbps (UL)
EDGE/GPRS Parameters	Supported frequencies: B3 (1800 MHz), B8 (900 MHz) Transfer rate: 296 kbps (DL), 236.8 kbps (UL)

Standards & Regulations	
Radio	EN 301 511, EN 301 908-1, EN 301 908-2, EN 301 908-13, EN 301 893, EN 300 328
EMC	ETSI EN 301489-1, ETSI EN 301489-17, ETSI EN 301489-52, EN 61000-4-2, EN 61000-4-3, EN 61000-4-4, EN 61000-4-5, EN 61000-4-6, IEC 61000-6-2, IEC 61000-6-3, EN 55032
Safety	EN IEC 62 368-1, IEEE 802.3
Transportation	E-mark
National	CE, UKCA
Mechanical	EN 60529
Climatic	EN 60068-2-1, EN 60068-2-2, EN 60068-2-14, EN 60068-2-30
Environmental	REACH, RoHS3, WEEE

Accessories

Part Number	Description	Included in the package
CON-ICR2-6-PWR	6-pin PWR / IO connector	✓
	Wall mount kit	✓
	Quick Start Guide	✓
BB-DIN-ICR32	DIN Clip	
BB-KD-ETH	Ethernet cross cable, length 1.5m	
ANT-LTE5G-025	Antenna 5G/LTE, Terminal, SMA-M	
BB-AW-A2458G-FSRPK	Antenna Wi-Fi, 2.4 & 5.8 GHz	
RPS-ICR2-EU	Power Supply, ICR2, 12V/1A, 6-pin, EU plug	
ACC-KIT-ICR2-001	ICR-2000 family accessory kit 2x LTE ANT, Power Supply, ETH cable	

*For more Antenna accessories visit www.advantech.com

Software	
Operating System	ICR-OS (Linux based)
SW Customization	Router App (User Modules)
Application Development	Open Linux, *Python, BASH, C/C++
Industrial Protocols and IoT	*DF1, *DNP3, *MQTT, *LWM2M
Networking Features and Protocols	DHCP, NAT/PAT, SSH, VRRP, PPPoE, SNMP, SMTP, Dynamic DNS client, DNS proxy, VLAN, QoS, *DMVPN, NTP Client/Server, *Routing protocols RIP, BGP, OSPF, IS-IS, NHRP, Backup Routes, Port Forwarding, Host Port Routing, Ethernet Bridging, Load Balancing, IPv6 Dual Stack
Security	HTTPS, SSH, SFTP, DMZ, Firewall (IP Filtering, MAC address filtering, Inbound and outbound Port filtering) VPN Tunneling – WireGuard, OpenVPN, *EasyVPN, IPsec with IKEv1 and IKEv2, GRE, L2TP, PPTP Authentication – RADIUS, TACACS+, *SCEP Encryption – DES, 3DES, AES, RSA, MD5, SHA
Firmware Management	Automatic firmware updates – server, locally via LAN or remotely via WAN
Diagnostic/Log	Status – Signal Strength, Data Usage One CLICK report – Current Configuration, Factory Identification, Routing Table Log – System Log, Reboot Log, Kernel Log Remote Diagnostics (via SSH)
Event Engine	StartUp script & Up/Down script (Own rules based on Digital Inputs, Network Parameters, Data Usage, Timer) Report Types: SMS, email, SNMP Trap
Configuration	Web server, SSH, Four configuration switchable profiles, Automatic configuration update from server, Backup & Restore configuration
Advanced Software Tools	WebAccess/DMP – Remote Device Provisioning, Monitoring & Management Platform WebAccess/VPN – Advanced Secure Networking Platform

*Functionality is available with installed Router App (User Module)

Views

FRONT VIEW

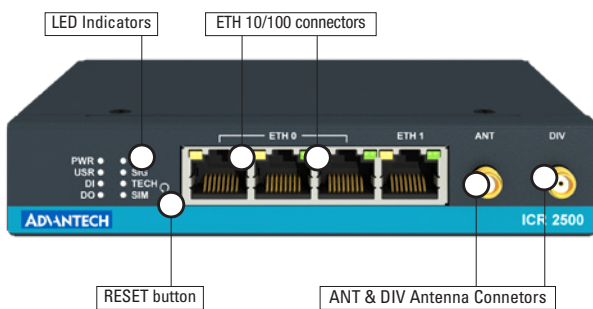

LEFT SIDE VIEW

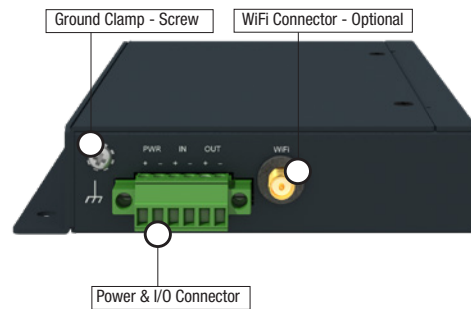

RIGHT SIDE VIEW

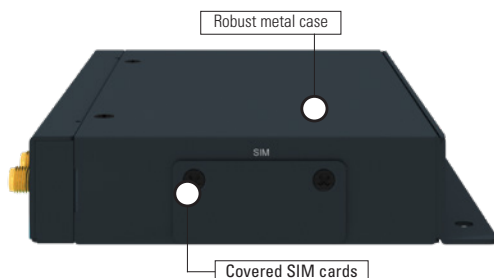

REAR VIEW

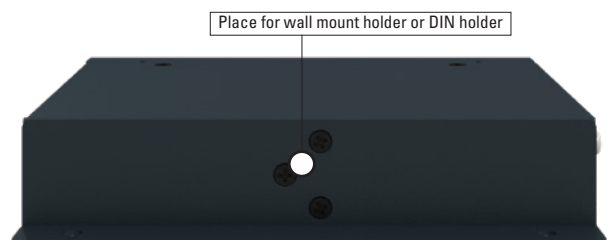

Dimensions - Technical Drawing

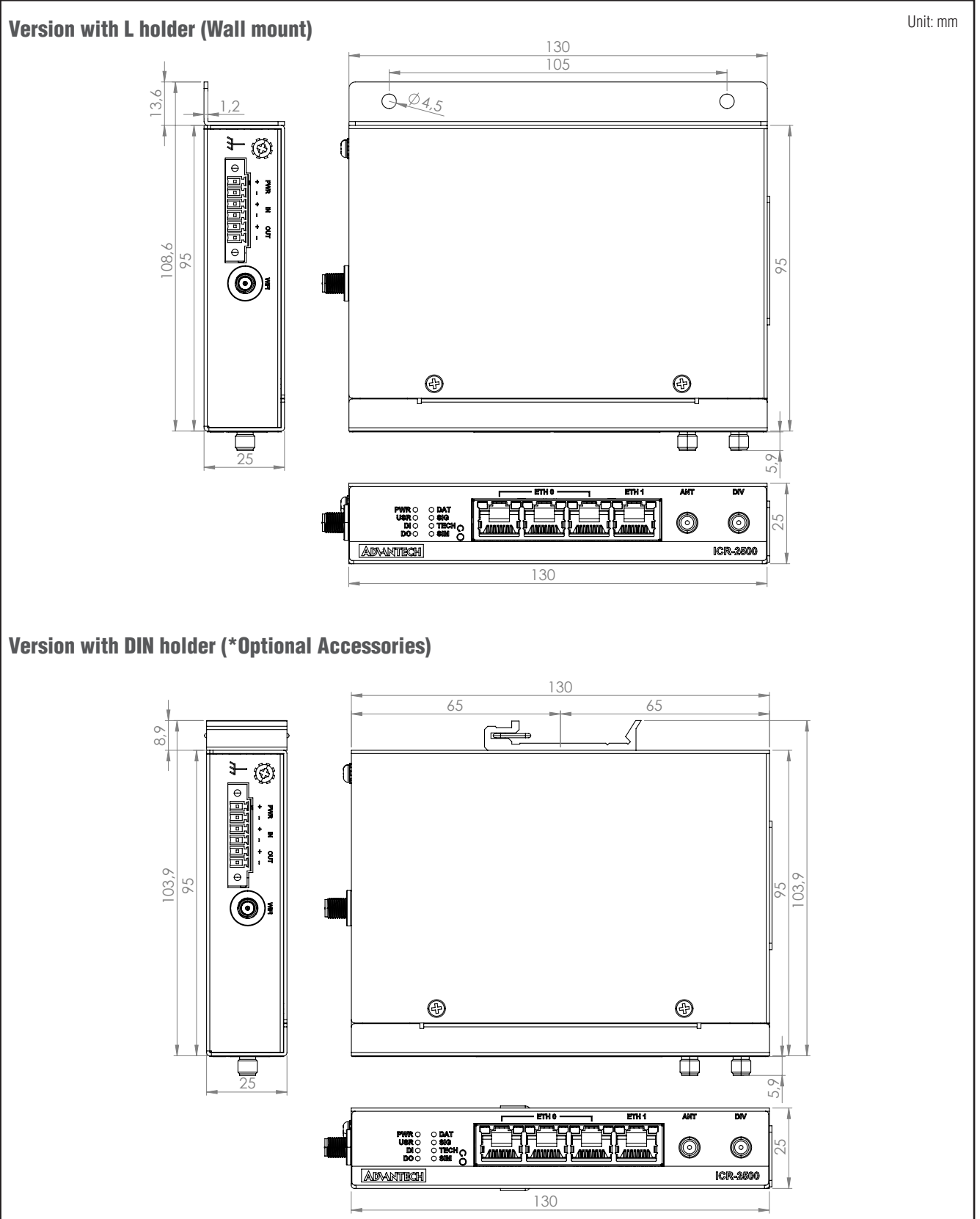

Tento produkt můžete zakoupit u společnosti AutoCont IPC a.s.



AutoCont IPC a.s.

Váš dodavatel průmyslových počítačů, komponent a speciálních průmyslových IT systémů.

 Uhlířská 1064/3, 710 00 Ostrava, Česká republika

 obchod@autocont-ipc.cz

 +420 552 301 002

 www.autocont-ipc.cz



PRŮMYSLOVÉ POČÍTAČE

fanless embedded PC, do racku, ...



POČÍTAČE S DISPLEJEM

panelové PC, terminály, do vozidel, ...



AUTOMATIZACE A SBĚR DAT

převodníky, karty, moduly, switche, ...



PERIFERIE A KOMPONENTY

monitory, klávesnice, desky, skříně, ...



NOTEBOOKY A TABLETY

odolné, windows, android, IP65, ...



INFORMAČNÍ KIOSKY

interiérové, venkovní, ...



MEDICÍNSKÁ TECHNIKA

počítače, tablety, LCD, klávesnice, ...



SOFTWAREVÁ ŘEŠENÍ

pro výrobu, zaměstnance, kiosky, ...



PŘEJÍT DO E-SHOPU

eshop.autocont-ipc.cz



DOPRAVA ZDARMA

Doprava zdarma v ČR a SR při objednávce nad 10 000 Kč bez DPH nebo nad 400 EUR.



PRODLOUŽENÁ ZÁRUKA

Záruka 2 roky na vyráběné počítače s možností jejího prodloužení až na 5 let.



ODMĚNA ZA VĚRNOST

Pravidelní zákazníci u nás nakupují za nižší ceny. Výše slevy se odvíjí od realizovaného obrátu.



SERVIS ON-SITE A IN-TIME

K projektovým dodávkám nabízíme rozšířenou podporu a servis s garancí výměny zařízení do 48 hodin.