

## ICR-2041

Entry-Level 4G Router



### Features

- LTE Cat.4 with 3G fallback
- 1× SIM
- 1× Ethernet, RJ45, 10/100 Mbps
- 1× DI, 1× DO
- Wide operational temperature range
- Wall and DIN mount options
- Linux based OS & SW customization
- Carriers support: Verizon, AT&T, T-Mobile

### Introduction

Industrial cellular router ICR-2041 is designed for wireless communication to enable connection of IP devices to a cellular network. Industrial M2M and IoT applications include kiosks, industrial PCs, HMIs, traffic controllers, meters, UPS systems, and much more. The peak downlink data rate for LTE Cat.4 is approximately 150 Mbps. Also in the uplink, LTE Cat.4 provides a peak data rate of 50 Mbps.

The router is equipped with one Ethernet port (LAN) and with digital I/O connectivity (1x DI, 1x DO). The router supports VPN tunnel creation using various protocols to ensure safe communications. The router provides diagnostic functions which include automatic monitoring of the wireless and wired connections, automatic restart in case of connection losses, and a hardware watchdog that monitors the router status.

Router is based on ICR-OS operation system. Open Linux platform enable wide possibilities of programming customer SW applications in Python, C/C++. Router supports uploading of RouterApps that would extend standard firmware functionalities. Existing app library ready for free download by customer contains already developed software apps to enhance specific router functionality including industrial protocol conversions, support of IoT platforms such as MS Azure, Cumulocity, ThingWorx and a lot more.



WebAccess/VPN



WebAccess/DMP



### Order Codes

Model no. - Order Codes	REGION	1× Ethernet	I/O	1× ANT 1× DIV	1× SIM
 ICR-2041	NAM	✓	✓	✓	✓

### Specifications

System	
CPU	ARM926EJ-S, 600 MHz
Memory	RAM - 128 MB NOR Flash - 64 MB (12 MB for Router Apps, 2 MB for customer data)
Watchdog	HW Watchdog
RTC	Battery backup RTC
Interfaces	
Ethernet	1× Ethernet, RJ45, 10/100 Mbps, 1.5 kV
I / O	1× Digital Input (36V/0.5 mA) 1× Digital Output (Open Drain, 36 V/ 100 mA) (6-pin terminal block together with PWR)
Reset Button	Reboot / Factory reset
LED Indicators	System, Signal strength, Data activity, SIM1/SIM2 status, Mobile technology, Input, Output, User, ETH

Environmental	
Power Supply	9 – 48 V DC (6-pin terminal block together with I/O)
Consumption	Idle 1.8 W / Average 2.8 W / Maximum 3.3 W
Operating Temperature	-40 to +75 °C
Storage Temperature	-40 to +85 °C
Humidity	5 to 95 %
IP Cover	IP30
Physical Characteristics	
Dimensions	103 mm x 95 mm x 25 mm
Enclosure	Metal Case, Grounding Screw
Mounting	Wall mount, * Optional DIN Rail mount
Weight	290 g

Cellular Interface	
SIM Slots	1× SIM (Micro SIM – 3FF)
Antennas	2× SMA connector (1× ANT, 1× DIV)
LTE Parameters	Supported FDD frequencies: B2 (1900 MHz), B4 (1700 MHz), B5 (850 MHz), B12 (700 MHz), B13 (700 MHz), B14 (700 MHz), B66 (1700 MHz), B71 (600 MHz) Transfer rate: 150 Mbps (DL), 50 Mbps (UL)
HSPA+/UMTS Parameters	Supported frequencies: , B2 (1900 MHz), B4 (1700 MHz), B5 (850 MHz) Transfer rate: 4.2 Mbps (DL), 2.2 Mbps (UL)

Standards & Regulations	
Certifications ongoing (Subject to change)	
Radio	FCC part 22H, FCC part 24E, FCC part 27, PTCRB
EMC	EN 61000-6-2, FCC part 15.B, ICES-003 Issue 6
Safety	IEC 62368-1
National	FCC, IC
Carrier Approval	Verizon, AT&T, T-Mobile
Mechanical	EN 60068-2-27, EN 60068-2-64, EN 60068-2-64, MIL-STD-810G, SAE J1455
Climatic	EN 60068-2-2, EN 60068-2-1, EN 60068-2-14, EN 60068-2-78, MIL-STD-810G, SAE J1455
Environmental	REACH, RoHS3, WEEE
Cellular Module Approvals*	Regulatory: GCF, FCC, IC, PTCRB Carrier: Verizon, AT&T (FirstNet), T-Mobile, U.S. Cellular, Rogers, Telus

\*Approvals are valid for the integrated cellular module inside the router only. Cellular module approvals are not always applicable for the whole router – see “Standards and Regulations” chart for complete router approvals available.

### Accessories

Part Number	Description	Included in the package
CON-ICR2-6-PWR	6-pin PWR / IO connector	✓
	Wall mount kit	✓
	Quick Start Guide	✓
BB-DIN-ICR32	DIN Clip	
BB-KD-ETH	Ethernet cross cable, length 1.5m	
ANT-LTE5G-025	Antenna 5G/LTE, Terminal, SMA-M	
RPS-ICR2-US	Power Supply, ICR2, 12V/1A, 6-pin, US plug	

\*For more Antenna accessories visit [www.advantech.com](http://www.advantech.com)

Software	
Operating System	ICR-OS (Linux based)
SW Customization	Router App
Application Development	Open Linux, *Python, BASH, C/C++
Industrial Protocols and IoT	*Modbus RTU/TCP gateway, *IEC 60870-5-101 to 104 gateway, *DF1, *DNP3, *MQTT, *LWM2M
Networking Features and Protocols	DHCP, NAT/PAT, SSH, VRRP, PPPoE, SNMP, SMTP, Dynamic DNS client, DNS proxy, VLAN, QoS, *DMVPN, NTP Client/Server, *Routing protocols RIP, BGP, OSPF, IS-IS, NHRP, Backup Routes, Port Forwarding, Host Port Routing, Ethernet Bridging, Load Balancing, IPv6 Dual Stack
Security	HTTPS, SSH, SFTP, DMZ, Firewall (IP Filtering, MAC address filtering, Inbound and outbound Port filtering) VPN Tunneling – WireGuard, OpenVPN, *EasyVPN, IPsec with IKEv1 and IKEv2, GRE, L2TP, PPTP Authentication – RADIUS, TACACS+, 2FA, *SCEP Encryption – DES, 3DES, AES, RSA, MD5, SHA
Firmware Management	Automatic firmware updates – server, locally via LAN or remotely via WAN
Diagnostic/Log	Status – Signal Strength, Data Usage One CLICK report – Current Configuration, Factory Identification, Routing Table Log – System Log, Reboot Log, Kernel Log Remote Diagnostics (via SSH)
Event Engine	StartUp script & Up/Down script (Own rules based on Digital Inputs, Network Parameters, Data Usage, Timer) Report Types: SMS, email, SNMP Trap
Configuration	Web server, SSH, Four configuration switchable profiles, Automatic configuration update from server, Backup & Restore configuration
Advanced Software Tools	WebAccess/DMP – Remote Device Provisioning, Monitoring & Management Platform WebAccess/VPN – Advanced Secure Networking Platform

\*Functionality is available with installed Router App

## Views

### FRONT VIEW

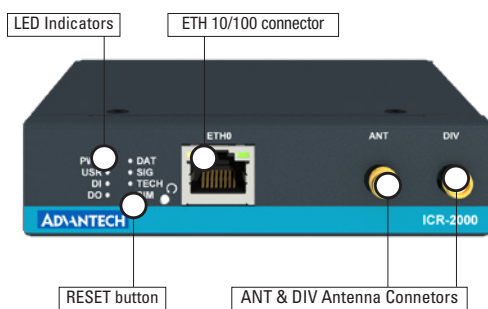

### LEFT SIDE VIEW

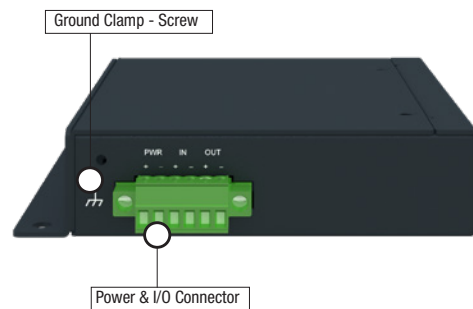

### RIGHT SIDE VIEW

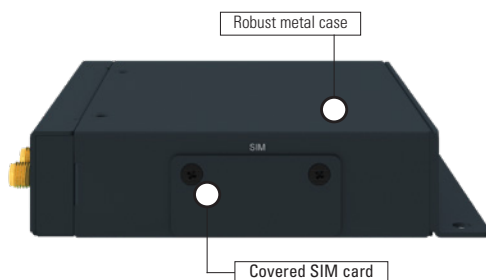

### REAR VIEW

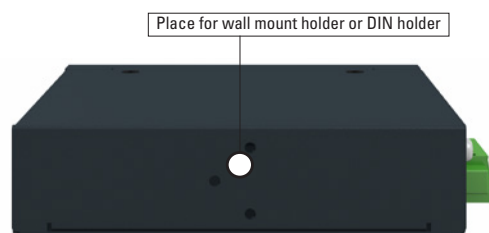

### Dimensions - Technical Drawing

Version with L holder (Wall mount)

Unit: mm

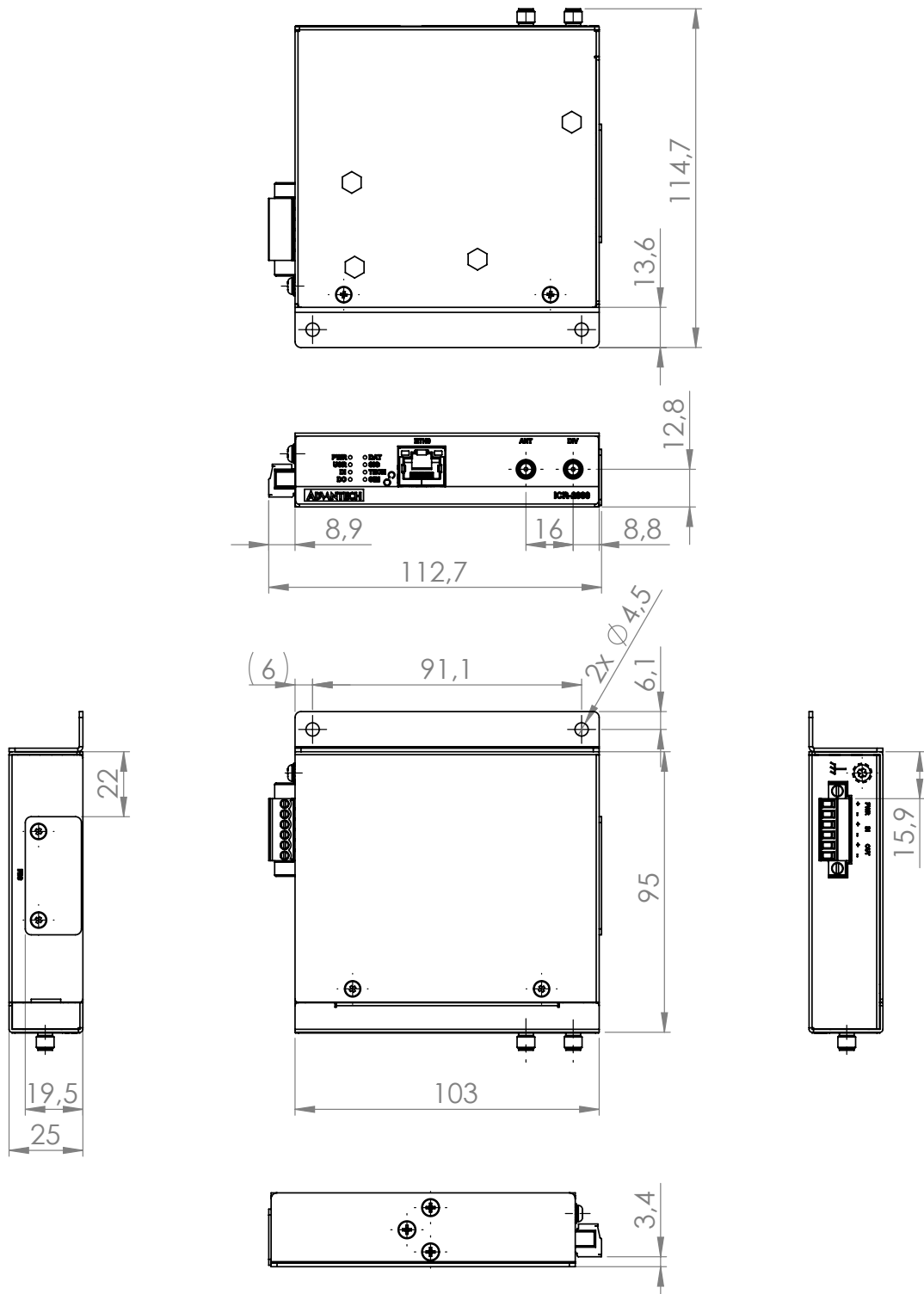

### Dimensions - Technical Drawing

Version with DIN holder (\*Optional Accessories)

Unit: mm

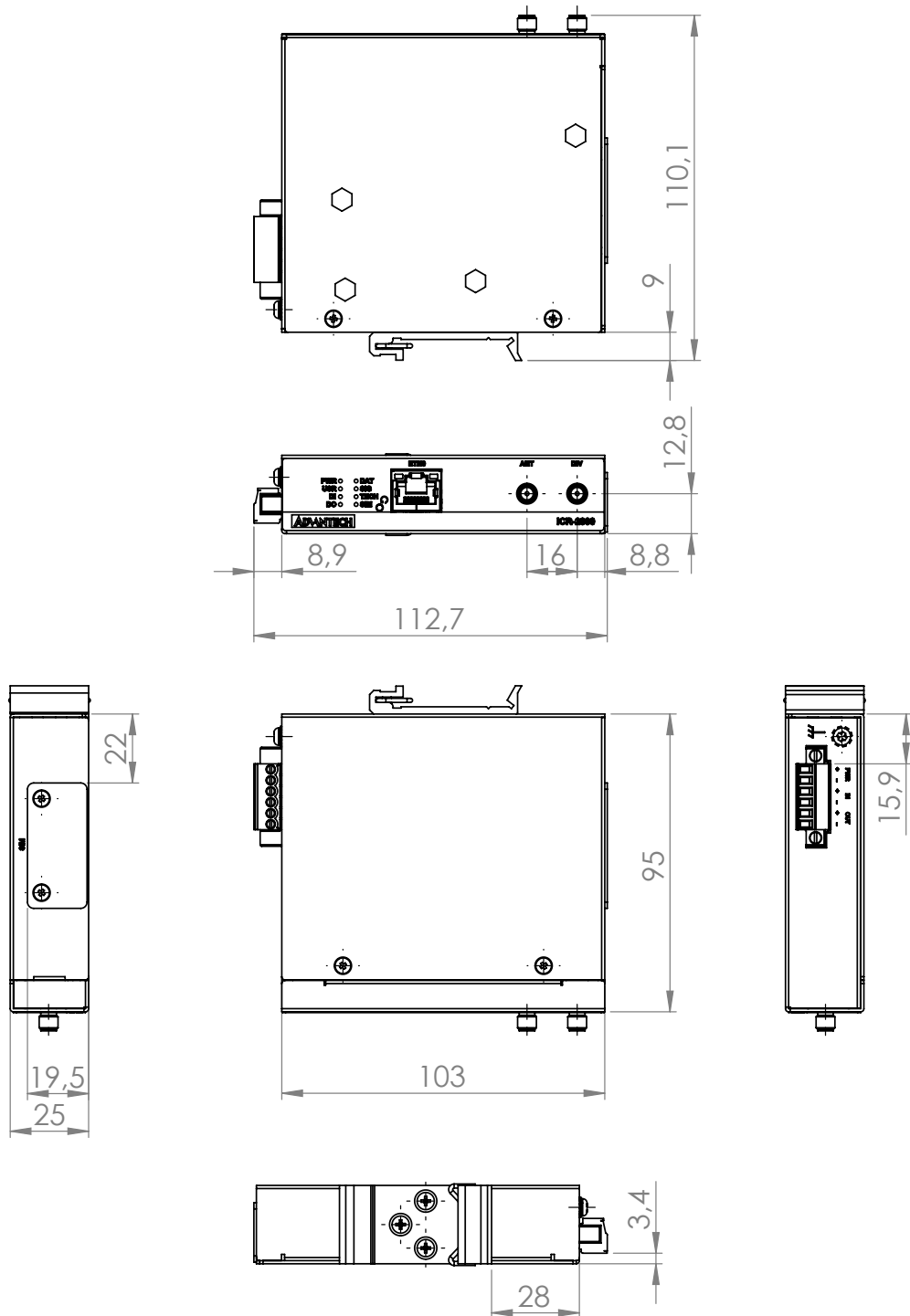

# Tento produkt můžete zakoupit u společnosti AutoCont IPC a.s.



## AutoCont IPC a.s.

Váš dodavatel průmyslových počítačů, komponent a speciálních průmyslových IT systémů.

 Uhlířská 1064/3, 710 00 Ostrava, Česká republika

 obchod@autocont-ipc.cz

 +420 552 301 002

 [www.autocont-ipc.cz](http://www.autocont-ipc.cz)



### PRŮMYSLOVÉ POČÍTAČE

*fanless embedded PC, do racku, ...*



### POČÍTAČE S DISPLEJEM

*panelové PC, terminály, do vozidel, ...*



### AUTOMATIZACE A SBĚR DAT

*převodníky, karty, moduly, switche, ...*



### PERIFERIE A KOMPONENTY

*monitory, klávesnice, desky, skříně, ...*



### NOTEBOOKY A TABLETY

*odolné, windows, android, IP65, ...*



### INFORMAČNÍ KIOSKY

*interiérové, venkovní, ...*



### MEDICÍNSKÁ TECHNIKA

*počítače, tablety, LCD, klávesnice, ...*



### SOFTWAREVÁ ŘEŠENÍ

*pro výrobu, zaměstnance, kiosky, ...*



### PŘEJÍT DO E-SHOPU

[eshop.autocont-ipc.cz](http://eshop.autocont-ipc.cz)



### DOPRAVA ZDARMA

Doprava zdarma v ČR a SR při objednávce nad 10 000 Kč bez DPH nebo nad 400 EUR.



### PRODLOUŽENÁ ZÁRUKA

Záruka 2 roky na vyráběné počítače s možností jejího prodloužení až na 5 let.



### ODMĚNA ZA VĚRNOST

Pravidelní zákazníci u nás nakupují za nižší ceny. Výše slevy se odvíjí od realizovaného obrátu.



### SERVIS ON-SITE A IN-TIME

K projektovým dodávkám nabízíme rozšířenou podporu a servis s garancí výměny zařízení do 48 hodin.