

ICR-4401

High Speed Wired Router & Powerfull Edge Computing Gateway



Features

- Quad-core CPU with 1 GB RAM
- 5x Gigabit Ethernet (Optional 4x PoE+ PSE)
- SFP Connector for SFP modules up to 10 Gbps
- TPM 2.0
- RS232, RS485, CAN BUS, 2x DI, 2x DO, USB Host
- Micro SD Card
- Robust metal cover with wall and DIN mount options
- Wide operational temperature range
- Optional Dual-Band Wi-Fi

Project based customization: SSD disc, Dual Concurrent WiFi AP, Bluetooth

Introduction

The ICR-4401 is a High-Speed Wired Router & Powerful Edge Computing Gateway. This router is an ideal solution for critical industrial systems and IIoT. It serves well also for connection of traffic and security camera systems, individual computers, LAN networks and various self-service terminals.

The new router platform "v4" provides intelligence at the network edge with an extremely powerful Cortex A72 CPU at 1200 MHz, 4 GB eMMC memory, 4 MB flash memory, and 1024 MB RAM. The focus on high security underlines using TPM 2.0, and Tamper Button that ensure safe use in critical infrastructure systems. The ICR-4401 is powered by the ICR-OS Linux operating system that provides a wide range of enhanced networking features. A secure Web interface allows users to configure and manage routers from remote locations.

The router supports multiple configuration profiles, automatic firmware updates, etc. The router can be used as a powerful edge computing gateway because of the support of many ways of software customization. Users may insert Linux scripts and add new features by additional applications called Router Apps (User Modules).

There is an existing free library of Router Apps or the user may create own app using Advantech SDK. The gateway can easily run applications like Node-RED or Docker that open the way to a multi-container world.









The ICR-4401 is designed and manufactured for use in tough environmental conditions. Specifications include a wide operating temperature ranges from -40 to +75 °C. It accepts input voltage range from 9 V DC to 48 V DC and is equipped with sleep mode for reducing electrical consumption.

As a standard, ICR-4401 is equipped with five Ethernet 10/100/1000 Mbps (1x independent and 4x switch), SFP cage (independent port), one USB host 2.0, microSD reader, serial lines RS232 and RS485, CAN Bus, two binary inputs, and two binary outputs. ICR-4401 has two mPCIe connectors that can be used for two WiFi modules. The router is supplied in a robust metal casing for a wall mount (DIN mount is optional).

ICR-4401 is easy to manage using WebAccess/DMP, full-featured cloud-based management, provisioning, and monitoring tool for mass deployment. The WebAccess/VPN is a perfect way how to create secure virtual private networks on the Internet.



WebAccess/DMP WebAccess/VPN

Model no. - Order Codes	REGION	5x Gigabit Ethernet	4x PoE PSE+	SFP cage (up to 10 Gbps)	RS232 RS485 CAN BUS	I/O	WiFi 802ac	Operating Temperature
 ICR-4401	GLOBAL*	✓		✓	✓	✓	NONE	-40 to +75 °C
 ICR-4401S	GLOBAL*	✓	✓	✓	✓	✓	NONE	-40 to +75 °C
 ICR-4401W	GLOBAL*	✓		✓	✓	✓	3x3 MIMO	-40 to +75 °C
 ICR-4401WS	GLOBAL*	✓	✓	✓	✓	✓	3x3 MIMO	-40 to +75 °C
 ICR-4401W1	GLOBAL*	✓		✓	✓	✓	3x3 MIMO	-40 to +60 °C
 ICR-4401W1S	GLOBAL*	✓	✓	✓	✓	✓	3x3 MIMO	-40 to +60 °C
 PLANNED ICR-4401W3	GLOBAL*	✓		✓	✓	✓	2x2 MIMO	-40 to +75 °C
 PLANNED ICR-4401W3S	GLOBAL*	✓	✓	✓	✓	✓	2x2 MIMO	-40 to +75 °C

* - Importer/operator needs to check locale legislation (standards, national approvals etc.) and compare with standards available for product if possible to operate the router in target region legally.

Specifications

System	
CPU	Quad-Core ARM Cortex-A72, 1200 MHz
Memory	RAM - 1024 MB eMMC - 4096 MB (838 MB for Router Apps, 512 MB for customer data)
Watchdog	HW Watchdog
RTC	Battery backup RTC
TPM	Trusted Platform Module (TPM) 2.0
Interfaces	
Ethernet	5× Ethernet (4+1), RJ45, 10/100/1000 Mbps *Optional 4× PoE PSE, IEEE 802.3at, 25.5W
SFP Cage	1× SFP cage (up to 10 Gbps)
Serial Lines	1× RS232 (Tx, Rx, GND, RTS, CTS) 1× RS485 (A(-), B(+), GND) 1× CAN (CAN_H, CAN_L) (14-pin terminal block)
I / O	2× Digital Input (3 mA consumption) 2× Digital Output (Open Drain, 48 V / 500 mA) (14-pin terminal block)
USB	1× USB 2.0 Host Connector
MicroSD Card	1× Micro SD Card Slot
Reset Button	Reboot / Factory reset
LED Indicators	System, User, 2× Input, 2× Output, ETH

Environmental	
Power Supply	9 – 48 V DC (2-pin terminal block)
Consumption	Without WiFi Idle 4.2 W / Average 4.2 W / Peak 12.5 W With WiFi Idle 5.4 W / Average 5.5 W / Peak 14.5 W PoE PSE without WiFi Idle 4.4 W / Average 4.6 W / Peak 127 W PoE PSE with WiFi Idle 5.7 W / Average 5.8 W / Peak 129 W
Sleep Mode	Yes, 24 mW, 310 mW for PoE PSE
Operating Temperature	-40 to +75 °C -40 to +60 °C - ICR-4401W1, ICR-4401W1S
Storage Temperature	-40 to +85 °C
Humidity	0 to 95 %
IP Cover	IP30
Physical Characteristics	
Dimensions	47 × 109 × 195 mm
Enclosure	Robust Metal Case, Grounding Screw
Mounting	Wall Mounting, DIN Rail (optional)
Weight	1350 g

WiFi - optional (ICR-4401W, ICR-4401WS, ICR-4401W1, ICR-4401W1S)	
Antenna	3× R-SMA connectors, 3×3 MIMO
Standards	IEEE802.11 ac/a/b/g/n 2.4 GHz / 5 GHz
Data Rate	Up to 600 Mbps @ 2.4 GHz Up to 1300 Mbps @ 5 GHz
Security	WEP, WPA, WPA2, WPA3, 802.1X
Modes	Access Point (unlimited clients), Station, Multirole STA & AP

WiFi - optional (ICR-4401W3, ICR-4401W3S) PLANNED	
Antenna	2× R-SMA connectors, 2×2 MIMO
Standards	IEEE802.11 ac/a/b/g/n 2.4 GHz / 5 GHz
Data Rate	Up to 300 Mbps @ 2.4 GHz Up to 867 Mbps @ 5 GHz
Security	WEP, WPA, WPA2, WPA3, 802.1X
Modes	Access Point (unlimited clients), Station, Multirole STA & AP

Standards & Regulations	
Radio	EN 301 893, EN 300 328
EMC	EN 301 489-1, EN 301 489-17, EN 61000-6-2, EN 55032, EN 61000-4-2, EN 61000-4-3, EN 61000-4-4, EN 61000-4-5, EN 61000-4-6
Safety	EN 62368-1, IEEE 802.3
Transportation	E-mark
National	CE, UKCA
Mechanical	EN 60068-2-27, EN 60068-2-64, EN 60529
Climatic	EN 60068-2-2, EN 60068-2-1, EN 60068-2-14, EN 60068-2-30
Environmental	RoHS3, Reach, WEEE

** - Models having ICR-4401W1, ICR-4401W1S order codes have no E8 certification.

Software	
Operating System	ICR-OS (Linux based)
SW Customization	Router App (User Modules)*
Application Development	Open Linux, *Python, BASH, C/C++, *Node-RED, *Docker
Networking Features and Protocols	DHCP, NAT/PAT, SSH, VRRP, PPPoE, SNMP, SMTP, Dynamic DNS client, DNS proxy, VLAN, QoS, *DMVPN, NTP Client/Server, *Routing protocols RIP, BGP, OSPF, IS-IS, NHRP, Backup Routes, Port Forwarding, Host Port Routing, Ethernet Bridging, Load Balancing, IPv6 Dual Stack
Industrial Protocols and IoT	*Modbus RTU/TCP gateway, *IEC 60870-5-101 to 104 gateway, *DF1, *DNP3, *MQTT, *LWM2M
Networking Features	DHCP, NAT/PAT, VRRP, Dynamic DNS client, DNS proxy, VLAN, QoS, *DMVPN, *WOL, NTP Client/Server, Backup Routes, Port Forwarding, Host Port Routing, Ethernet Bridging, Load Balancing, IPv6 Dual Stack
Security	HTTPS, SSH, SFTP, DMZ, Firewall (IP Filtering, MAC address filtering, Inbound and outbound Port filtering) VPN Tunneling – WireGuard, OpenVPN, *EasyVPN, IPsec with IKEv1 and IKEv2, GRE, L2TP, PPTP Authentication – RADIUS, TACACS+, 2FA, *SCEP Encryption – DES, 3DES, AES, RSA, MD5, SHA
Firmware Management	Automatic firmware updates – server, locally via LAN or remotely via WAN
Diagnostic/Log	Status – Data Usage, Detailed Long Term Statistics One CLICK report – Current Configuration, Factory Identification, Routing Table Log – System Log, Reboot Log, Kernel Log Remote Diagnostics (via SSH)
Event Engine	StartUp script & Up/Down script (Own rules based on Digital Inputs, Network Parameters, Data Usage, Timer, Power, Device Temperature) Report Types: Email, SNMP Trap
Configuration	Web server, SSH, Four configuration switchable profiles, Automatic configuration update from server, Backup & Restore configuration
Advanced Software Tools	WebAccess/DMP – Remote Device Provisioning, Monitoring & Management Platform WebAccess/VPN – Advanced Secure Networking Platform

*Functionality is available with installed Router App (User Module)

Accessories

Part Number	Description	Included in the package
BB-CON-WR2	2-pin PWR connector	✓
CON-ICR44-14	14-pin Serial / IO connector	
	Wall mount kit	
BB-DIN-ICR32	DIN clip (2 pcs are necessary for the mounting)	Optional
RPS-ICR4-WR2-M	Wall mount Power supply, 12 V/1.5 A, EU, UK, US, AUS plugs	
RPS-ICR4-WR2-PSE	Desktop Power supply POE PSE, 48 V / 1.35 A, (without Power Cord)	
BB-PWRCORD-AUS	AUS Power Cord (for RPS-ICR4-WR2-PSE)	
BB-PWRCORD-EU	EU Power Cord (for RPS-ICR4-WR2-PSE)	
BB-PWRCORD-UK	UK Power Cord (for RPS-ICR4-WR2-PSE)	
BB-PWRCORD-US	US Power Cord (for RPS-ICR4-WR2-PSE)	
BB-KD-ETH	Ethernet cross cable, 1.5 m, Shielded	
BB-AW-A2458G-FSRPK	Antenna Wi-Fi, 2.4 & 5.8 GHz (3 pcs are recommended for full 3x3 MIMO performance)	

For more accessories visit www.advantech.com

Views

FRONT VIEW

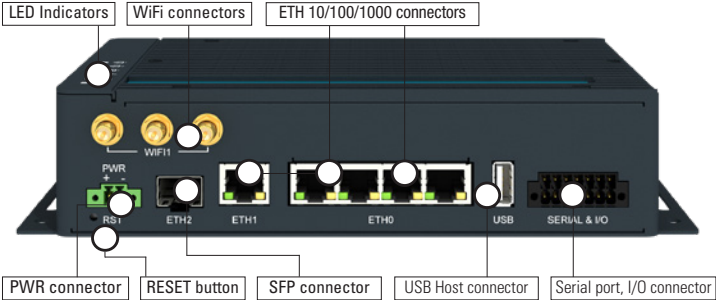

REAR VIEW

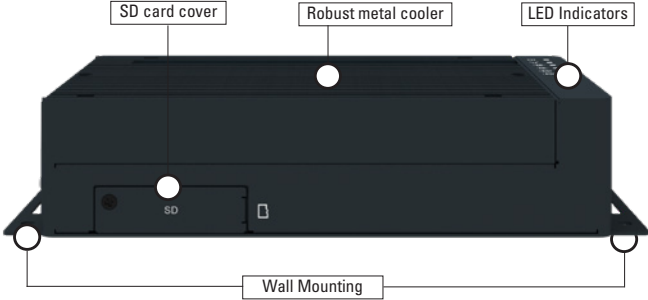

LEFT SIDE VIEW

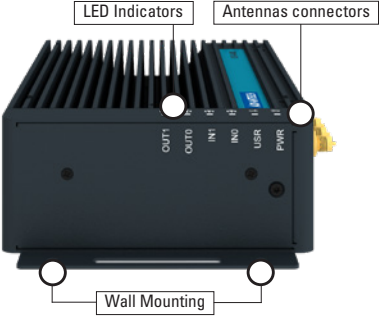

RIGHT SIDE VIEW

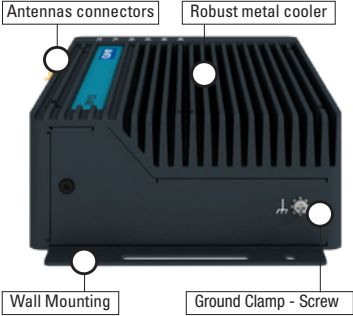

BOTTOM VIEW - WALL MOUNT KIT

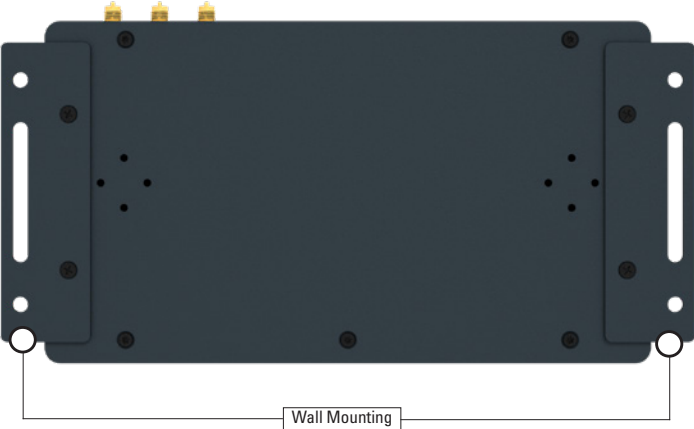

BOTTOM VIEW - DIN HOLDERS

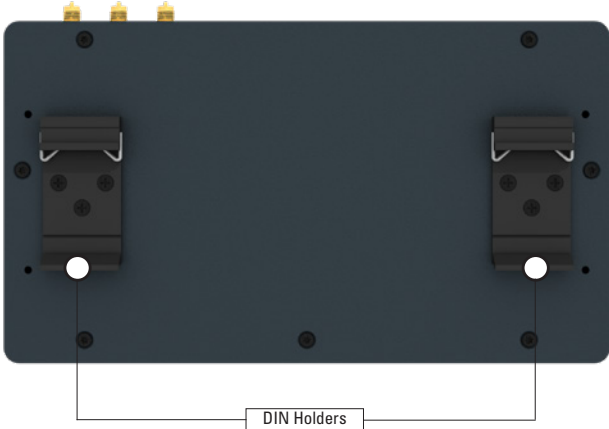

Dimensions - Technical Drawing - Wall Mount

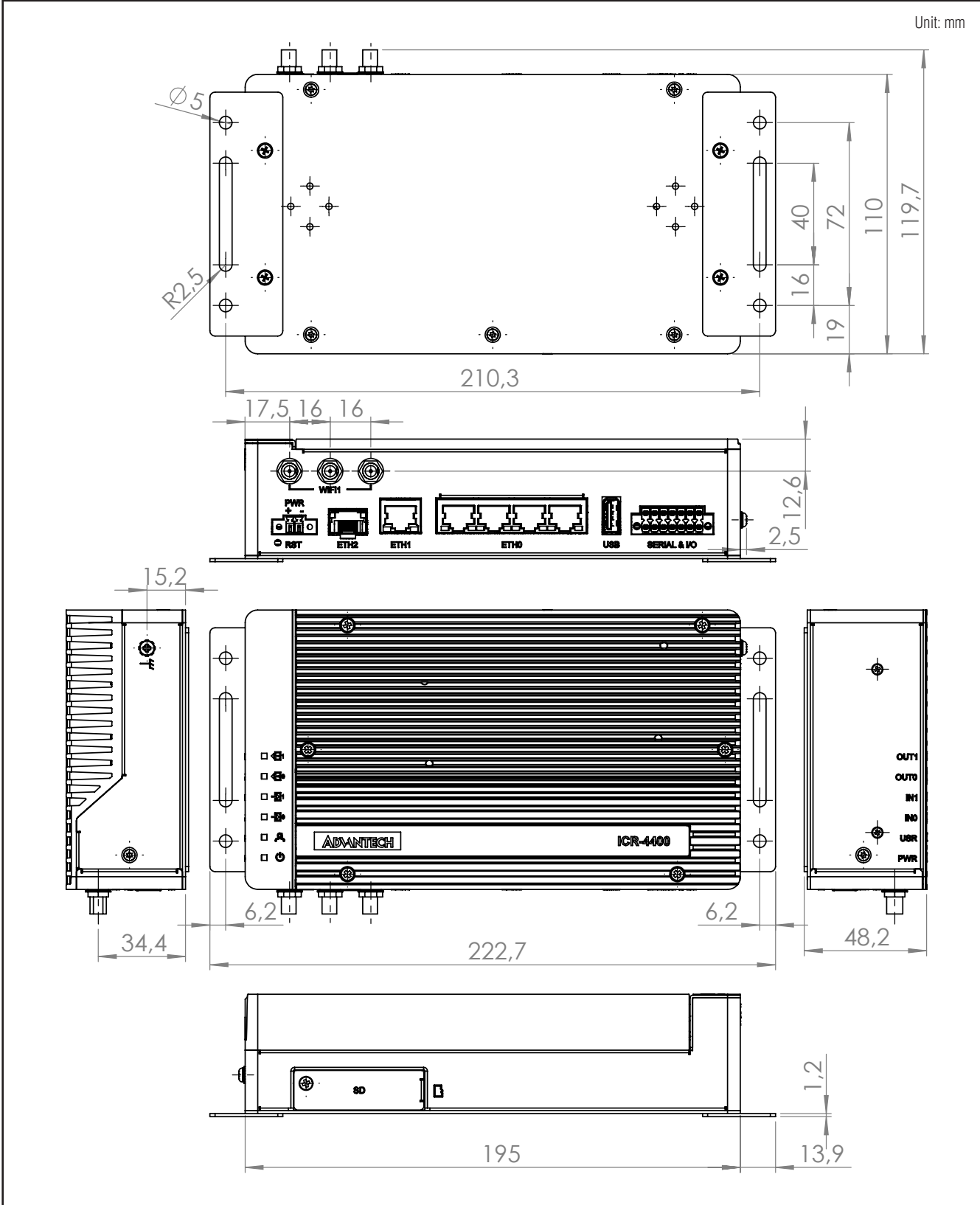

Dimensions - Technical Drawing - DIN Holders

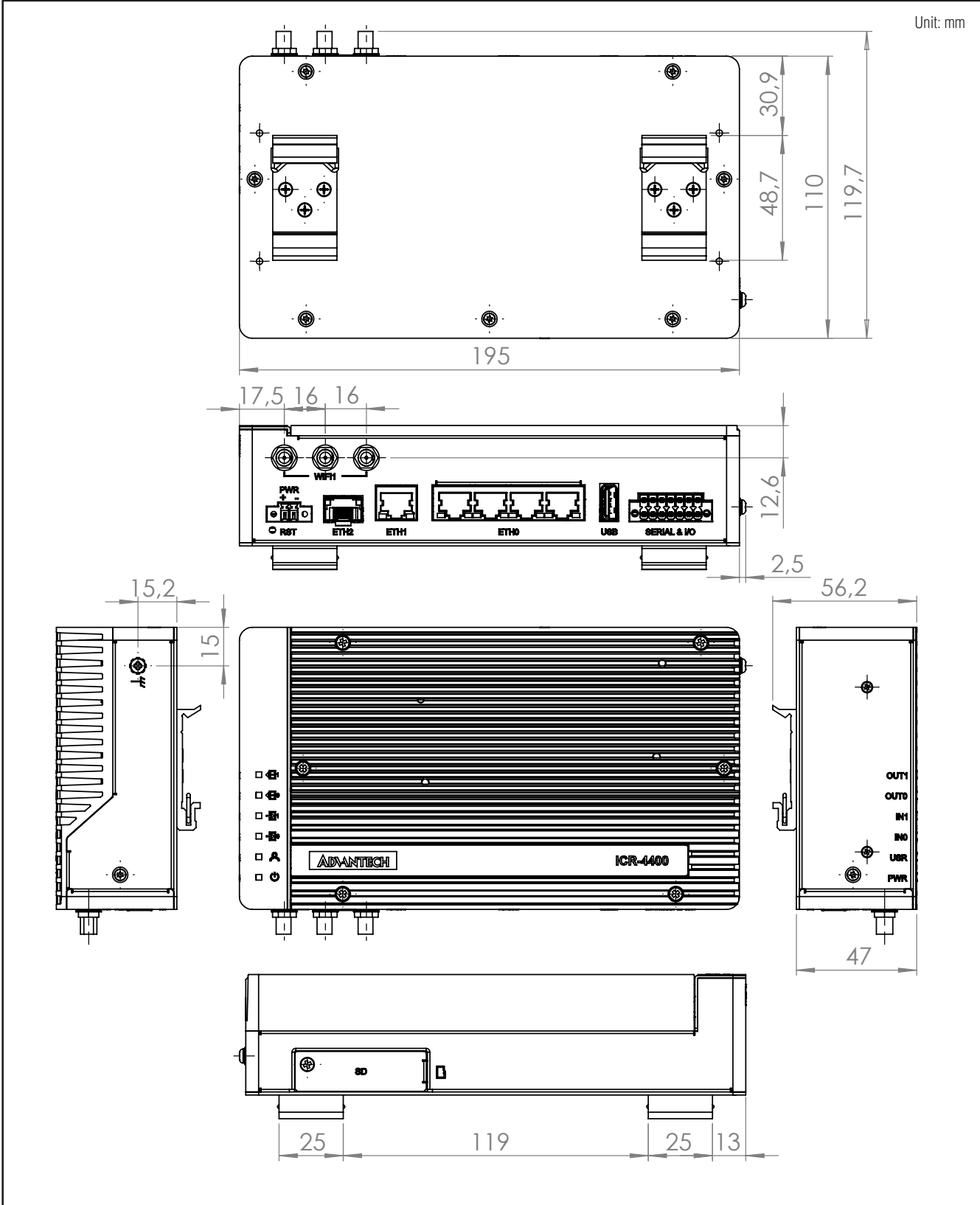

Tento produkt můžete zakoupit u společnosti AutoCont IPC a.s.



AutoCont IPC a.s.

Váš dodavatel průmyslových počítačů, komponent a speciálních průmyslových IT systémů.

 Uhlířská 1064/3, 710 00 Ostrava, Česká republika

 obchod@autocont-ipc.cz

 +420 552 301 002

 www.autocont-ipc.cz



PRŮMYSLOVÉ POČÍTAČE

fanless embedded PC, do racku, ...



POČÍTAČE S DISPLEJEM

panelové PC, terminály, do vozidel, ...



AUTOMATIZACE A SBĚR DAT

převodníky, karty, moduly, switche, ...



PERIFERIE A KOMPONENTY

monitory, klávesnice, desky, skříně, ...



NOTEBOOKY A TABLETY

odolné, windows, android, IP65, ...



INFORMAČNÍ KIOSKY

interiérové, venkovní, ...



MEDICÍNSKÁ TECHNIKA

počítače, tablety, LCD, klávesnice, ...



SOFTWAREVÁ ŘEŠENÍ

pro výrobu, zaměstnance, kiosky, ...



PŘEJÍT DO E-SHOPU

eshop.autocont-ipc.cz



DOPRAVA ZDARMA

Doprava zdarma v ČR a SR při objednávce nad 10 000 Kč bez DPH nebo nad 400 EUR.



PRODLOUŽENÁ ZÁRUKA

Záruka 2 roky na vyráběné počítače s možností jejího prodloužení až na 5 let.



ODMĚNA ZA VĚRNOST

Pravidelní zákazníci u nás nakupují za nižší ceny. Výše slevy se odvíjí od realizovaného obrátu.



SERVIS ON-SITE A IN-TIME

K projektovým dodávkám nabízíme rozšířenou podporu a servis s garancí výměny zařízení do 48 hodin.