

## ICR-2437

Entry-Level 4G Router



### Features

- LTE Cat.4 with 450 MHz support (B31 & B72)
- 2× SIM for redundancy
- 2× Ethernet 10/100 Mbps
- 1× RS232, 1× RS485
- 1× DI, 1× DO
- Wide operational temperature range
- Wall and DIN mount options
- Linux based OS & SW customization



### Introduction

Industrial cellular router ICR-2437 is designed for wireless communication in LTE 450 MHz networks as well as in standard 4G public European LTE networks. LTE 450 MHz brings deeper LTE signal penetration than standard 4G public LTE frequencies and is ideal for Industrial IoT and critical infrastructure applications.

The ICR-2437 offers a unique design supporting both LTE 450 MHz bands B31 and B72 in one single router unit. Router gateway construction provides state-of-the-art 450 MHz RF front-end design with excellent RF performance. In addition to LTE 450 MHz great performance, it allows users to communicate in standard high-speed public LTE networks (LTE Cat.4) with download speed up to 150 Mbps and upload speed up to 50 Mbps.

The router is equipped with two independently configurable Ethernet ports (LAN or WAN), 1× serial port RS232, 1× RS485, and with digital I/O connectivity (1× DI, 1× DO). The router supports VPN tunnel creation using various protocols to ensure safe communications. The router provides diagnostic functions which include automatic monitoring of the wireless and wired connections, automatic restart in case of connection losses, and a hardware watchdog that monitors the router status.

Router is based on ICR-OS operation system. Open Linux platform enable wide possibilities of programming customer SW applications in Python, C/C++. Router supports uploading of RouterApps (User modules) that would extend standard firmware functionalities. Existing app library ready for free download by customer contains already developed software apps to enhance specific router functionality including industrial protocol conversions, support of IoT platforms such as MS Azure, Cumulocity, ThingWorx and a lot more.



WebAccess/VPN



WebAccess/DMP



### Order Codes

Model no. - Order Codes	REGION	2× Ethernet 10/100 Mbps	RS232 RS485	I/O	1× ANT 1× DIV	2× SIM
 ICR-2437	EMEA	✓	✓	✓	✓	✓

### Specifications

System	
CPU	ARM926EJ-S, 600 MHz
Memory	RAM - 128 MB NOR Flash - 64 MB (12 MB for Router Apps, 2 MB for customer data)
Watchdog	HW Watchdog
RTC	Battery backup RTC
Interfaces	
Ethernet	2× Ethernet (1+1), RJ45, 10/100 Mbps
Serial Lines	1× RS232 (Tx, Rx, GND, RTS, CTS) 1× RS485 (A(-), B(+), GND) (7-pin terminal block)
I / O	1× Digital Input (48 V / 0.5 mA) 1× Digital Output (Open Drain, 48 V / 100 mA) (6-pin terminal block together with PWR)
Reset Button	Reboot / Factory reset
LED Indicators	System, Signal strength, Data activity, SIM1/SIM2 status, Mobile technology, Input, Output, User, ETH

Environmental	
Power Supply	9 – 48 V DC (6-pin terminal block together with I/O)
Consumption	Idle 2.6 W / Average 3.3 W / Maximum 4.2 W
Operating Temperature	-40 to +75 °C
Storage Temperature	-40 to +85 °C
Humidity	5 to 95 %
IP Cover	IP30
Physical Characteristics	
Dimensions	103 mm × 95 mm × 25 mm
Enclosure	Metal Case, Grounding Screw
Mounting	Wall mount, * Optional DIN Rail mount
Weight	345 g

Cellular Interface	
SIM Slots	2× SIM (Micro SIM – 3FF)
Antennas	2× SMA connector (1× ANT, 1× DIV)
LTE Parameters	Supported FDD frequencies: B3, B7, B20, B31, B72 Transfer rate: 150 Mbps (DL), 50 Mbps (UL)

Standards & Regulations	
Radio	EN 301 511, EN 301 908-1, EN 301 908-2, EN 301 908-13
EMC	EN 301 489-1, EN 301 489-19, EN 301 489-52, EN 61000-4-2, EN 61000-4-3, EN 61000-4-4, EN 61000-4-5, EN 61000-4-6, EN 61000-4-11
Safety	EN 62 368-1, IEEE 802.3
National	CE, UKCA
Mechanical	EN 60529
Climatic	EN 60068-2-1, EN 60068-2-2, EN 60068-2-14, EN 60068-2-30
Environmental	REACH, RoHS3, WEEE

### Accessories

Part Number	Description	Included in the package
CON-ICR2-6-PWR	6-pin PWR / IO connector	✓
CON-ICR2-7-SER	7-pin Serial connector	✓
	Wall mount kit	✓
	Quick Start Guide	✓
BB-DIN-ICR32	DIN Clip	
BB-KD-ETH	Ethernet cross cable, length 1.5m	
BB-WR-600N	Antenna LTE450, Terminal SMA-M	
RPS-ICR2-EU	Power Supply, ICR2, 12V/1A, 6-pin, EU plug	

\*For more Antenna accessories visit [www.advantech.com](http://www.advantech.com)

Software	
Operating System	ICR-OS (Linux based)
SW Customization	Router App (User Modules)
Application Development	Open Linux, *Python, BASH, C/C++
Industrial Protocols and IoT	*Modbus RTU/TCP gateway, *IEC 60870-5-101 to 104 gateway, *DF1, *DNP3, *MQTT, *LWM2M
Networking Features and Protocols	DHCP, NAT/PAT, SSH, VRRP, PPPoE, SNMP, SMTP, Dynamic DNS client, DNS proxy, VLAN, QoS, *DMVPN, NTP Client/Server, *Routing protocols RIP, BGP, OSPF, IS-IS, NHRP, Backup Routes, Port Forwarding, Host Port Routing, Ethernet Bridging, Load Balancing, IPv6 Dual Stack
Security	HTTPS, SSH, SFTP, DMZ, Firewall (IP Filtering, MAC address filtering, Inbound and outbound Port filtering) VPN Tunneling – WireGuard, OpenVPN, *EasyVPN, IPsec with IKEv1 and IKEv2, GRE, L2TP, PPTP Authentication – RADIUS, TACACS+, 2FA, *SCEP Encryption – DES, 3DES, AES, RSA, MD5, SHA
Firmware Management	Automatic firmware updates – server, locally via LAN or remotely via WAN
Diagnostic/Log	Status – Signal Strength, Data Usage One CLICK report – Current Configuration, Factory Identification, Routing Table Log – System Log, Reboot Log, Kernel Log Remote Diagnostics (via SSH)
Event Engine	StartUp script & Up/Down script (Own rules based on Digital Inputs, Network Parameters, Data Usage, Timer) Report Types: SMS, email, SNMP Trap
Configuration	Web server, SSH, Four configuration switchable profiles, Automatic configuration update from server, Backup & Restore configuration
Advanced Software Tools	WebAccess/DMP – Remote Device Provisioning, Monitoring & Management Platform WebAccess/VPN – Advanced Secure Networking Platform

\*Functionality is available with installed Router App (User Module)

## Views

### FRONT VIEW

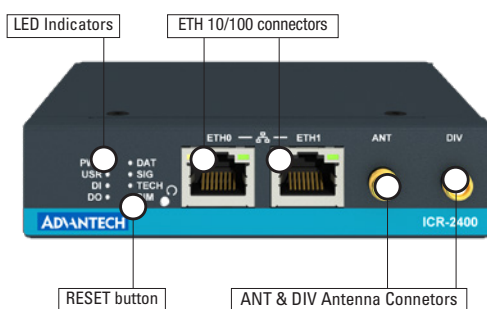

### LEFT SIDE VIEW

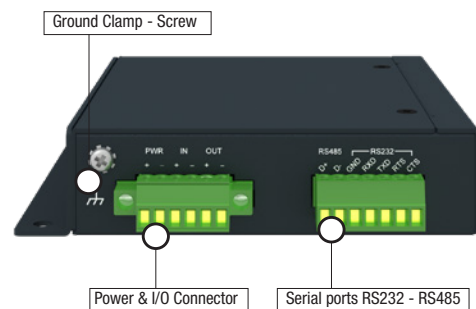

### RIGHT SIDE VIEW

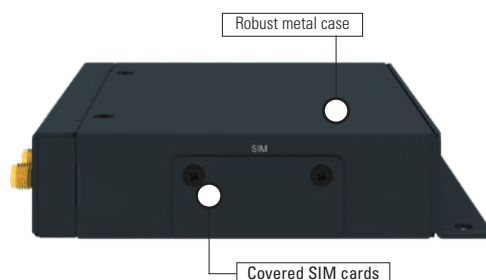

### REAR VIEW

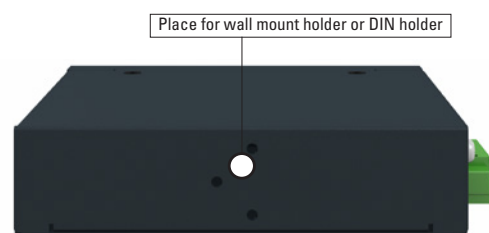

### Dimensions - Technical Drawing

Version with L holder (Wall mount)

Unit: mm

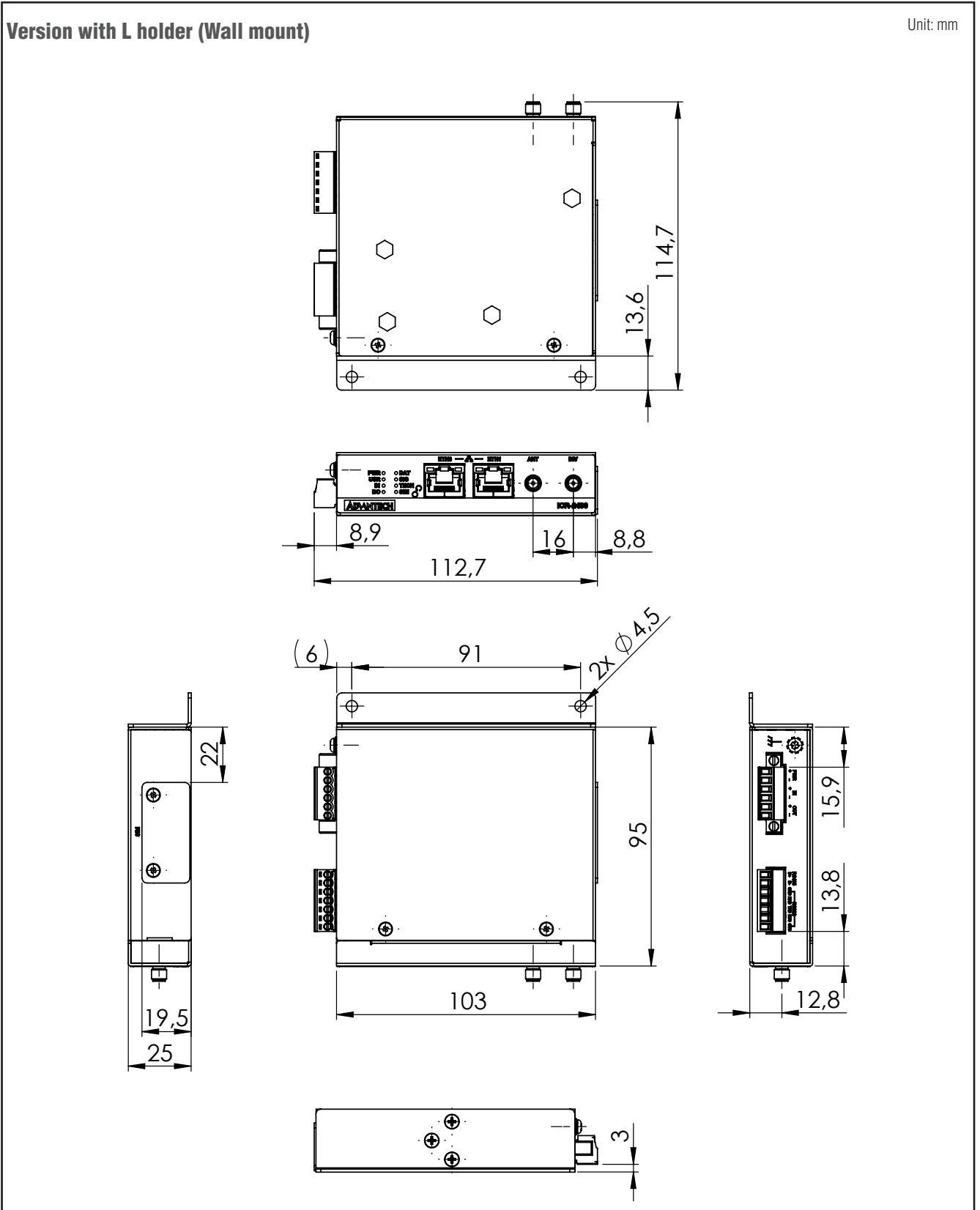

### Dimensions - Technical Drawing

Version with DIN holder (\*Optional Accessories)

Unit: mm

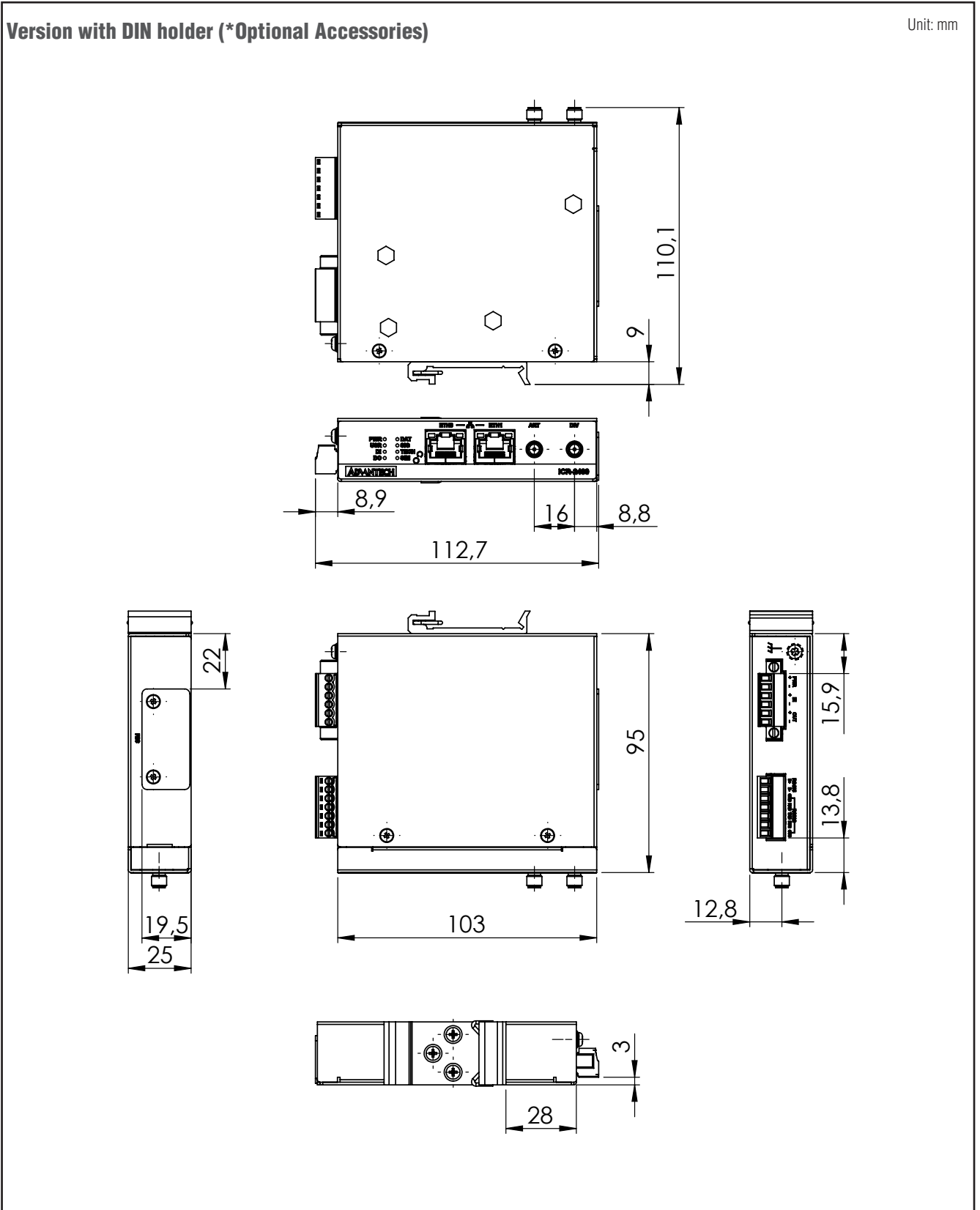

# Tento produkt můžete zakoupit u společnosti AutoCont IPC a.s.



## AutoCont IPC a.s.

Váš dodavatel průmyslových počítačů, komponent a speciálních průmyslových IT systémů.

 Uhlířská 1064/3, 710 00 Ostrava, Česká republika

 obchod@autocont-ipc.cz

 +420 552 301 002

 [www.autocont-ipc.cz](http://www.autocont-ipc.cz)



### PRŮMYSLOVÉ POČÍTAČE

*fanless embedded PC, do racku, ...*



### POČÍTAČE S DISPLEJEM

*panelové PC, terminály, do vozidel, ...*



### AUTOMATIZACE A SBĚR DAT

*převodníky, karty, moduly, switche, ...*



### PERIFERIE A KOMPONENTY

*monitory, klávesnice, desky, skříně, ...*



### NOTEBOOKY A TABLETY

*odolné, windows, android, IP65, ...*



### INFORMAČNÍ KIOSKY

*interiérové, venkovní, ...*



### MEDICÍNSKÁ TECHNIKA

*počítače, tablety, LCD, klávesnice, ...*



### SOFTWAREVÁ ŘEŠENÍ

*pro výrobu, zaměstnance, kiosky, ...*



### PŘEJÍT DO E-SHOPU

[eshop.autocont-ipc.cz](http://eshop.autocont-ipc.cz)



### DOPRAVA ZDARMA

Doprava zdarma v ČR a SR při objednávce nad 10 000 Kč bez DPH nebo nad 400 EUR.



### PRODLOUŽENÁ ZÁRUKA

Záruka 2 roky na vyráběné počítače s možností jejího prodloužení až na 5 let.



### ODMĚNA ZA VĚRNOST

Pravidelní zákazníci u nás nakupují za nižší ceny. Výše slevy se odvíjí od realizovaného obrátu.



### SERVIS ON-SITE A IN-TIME

K projektovým dodávkám nabízíme rozšířenou podporu a servis s garancí výměny zařízení do 48 hodin.