

# AVAS-212

## Medical-Grade Video Streamer



### Features

- Simultaneously use as an encoder and a decoder
- Zero latency to ensure excellent Hand/Eye coordination
- Ultra fast, lossless video transmission over IP
- All signals (video, images, audio, USB, and more) are transported via 10Gb optical fiber
- Multiple video sources can be displayed simultaneously on a screen with integrated video management
- Mouse and keyboard control the system behind the displayed images with superior hand/eye coordination even in QuadView or MultiView mode
- An open API enables user to integrate the product into environment or workflow management system

### Specifications

Video	Input / Output Resolution	- 4Kp60 HDMI: 4Kp60 UHD (4096 x 2160, 60 frame rate), 1 x uncompressed video - 4Kp30 HDMI: 4Kp30 UHD (4096 x 2160, 30 frame rate), 1 x uncompressed video - FHDp60 DVI: 4Kp30 UHD (1920 x 1080, 60 frame rate), 1 x uncompressed video
	Direct display	Uncompressed video, latency < 1 frame
	Seamless switching	Latency 1 frame
	MultiView	Picture-in-Picture, Side-by-Side, Quad view, 1+3 bottom, 1+3 right
Audio	Audio	Analog audio in/out
Network	Network Bandwidth	10GbE
	Network Cabling	SFP+
	Video In	- 4Kp60 HDMI : 1 x HDMI 2.0 input - 4Kp30 HDMI : 1 x HDMI 1.4 Input - FHD DVI : 1 x DVI-D input single link
	Video Out	- 4Kp60 HDMI : 1 x HDMI 2.0 output - 4Kp30 HDMI : 1 x HDMI 1.4 output - FHD DVI : 1 x DVI-D output single link
	RS232	1 x RJ-10 type connector (no function, for future use)
	Audio out/in	2 for Audio out/in 3.5mm stereo jack connectors
	USB device	1 for USB 2.0 type B connector
	USB host	2 for USB 2.0 host type A connectors
	Grounding	1 x Equipotential Terminal
	DC input jack	1 for 12V DC power in
	Ethernet	1 RJ45 1GbE (no function, for future use)
	Status LED	1 for indicate the AVAS-212 operational status
	SFP+ slot	1 for SFP+ module only
Power		External Medical PSU, 100-240V AC NDcoder AVAS-212, 12V/2A DC
Certification		FCC, UL 60601, CE EN60601, CB EN60601, MDD, CCC
Environment	Operation temperature	0 °C to +40 °C
	Storage temperature	-10 °C to +50 °C
Physical Characteristics	Dimension	176.5 x 220 x 44 mm
	Weight	1.3 kg
	VESA mount	75 x 75 mm
Accessories		12V DC Medical Power Support Unit (PSU)

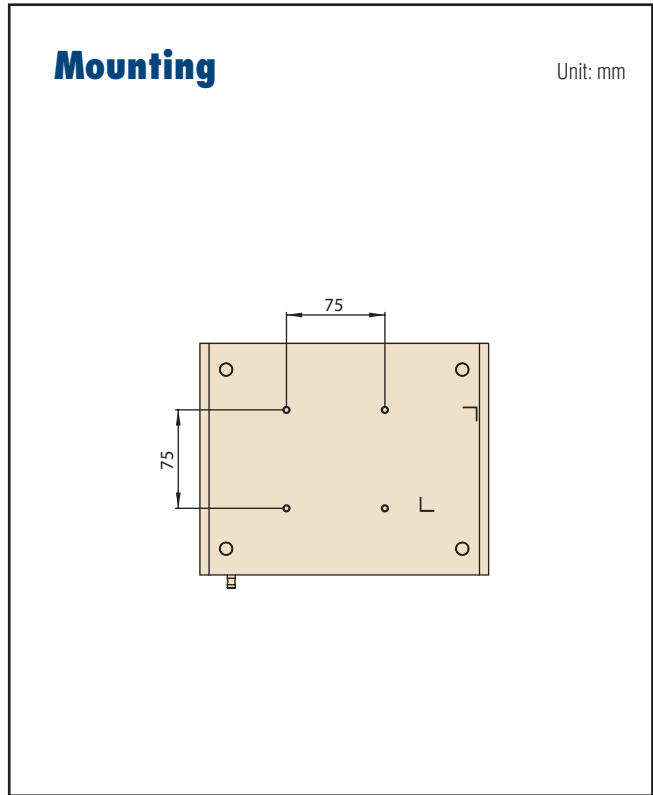
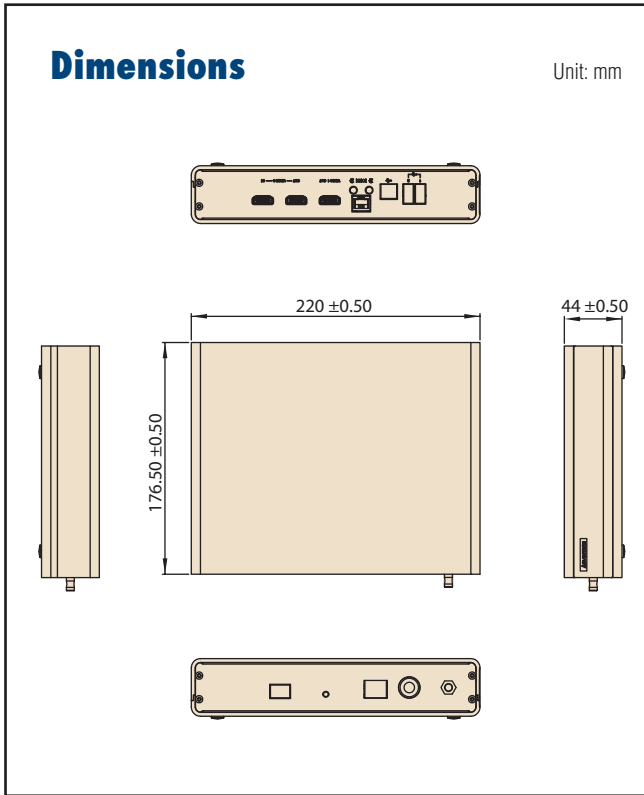

## I/O

### 4Kp60 HDMI Version

#### Front Side

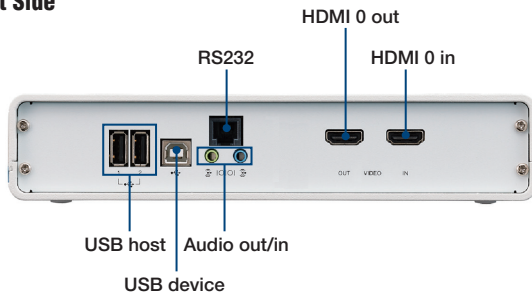

### 4Kp30 HDMI Version

#### Front Side

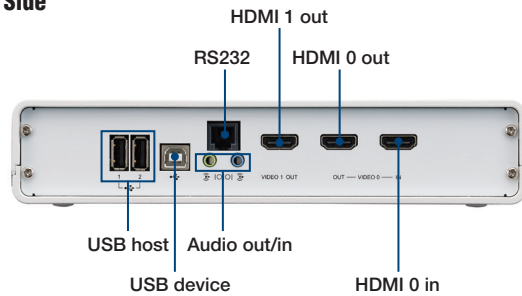

### FHDp60 DVI Version

#### Front Side

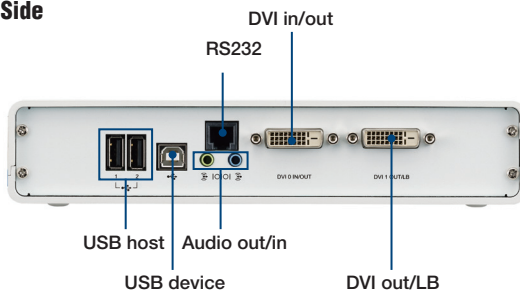

### AVAS-212 Video Streamer

#### Rear Side

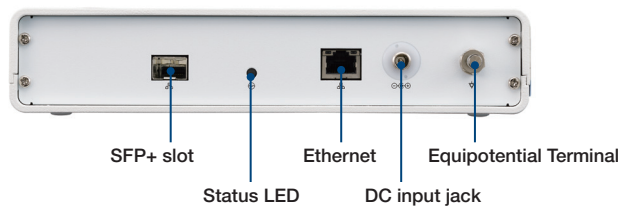

\*AVAS-212 can be integrated in PAX series surgical monitor, please go to <http://www.advantech.com> to refer surgical monitor introduction.

## Ordering Information

Part Number	Description
AVAS-212-KNNO-D00	HDMI / Decoder or Encoder / 4Kp60 UHD / StreamingBox
AVAS-212-HNNO-D00	HDMI / NDCoder / 4Kp30 UHD / StreamingBox
AVAS-212-VNNO-D00	DVI / NDCoder / 1080p FHD / StreamingBox

## Optional Items

Part Number	Description
AVAS-OPAC-0001	10G Networking Transceiver Module
AVAS-OPAC-0002	1G Networking Transceiver Module
AVAS-OPAC-0004	Networking Switch 16 Port
AVAS-OPAC-0005	Masternode Server
AVAS-OPAC-0006	10 inch Touch Control Panel
XAVAS-HPU32A-105	Power Adaptor 100-240V 30W 12V MED DC Jack
1702002600	Power Cord UL 3P 10A 125V 183cm
1702002605	Power Cord EU 3P 10A 250V 183cm
1700024369-01	HDMI-to-HDMI Cable 19P(M)/HDMI 19P(M) 1M
1700000243-11	DVI-to-DVI Cable 19P(M)/HDMI 19P(M) 2M
1700023491-01	DVI-to-HDMI Cable 19P(M)/DVI 19P(M) 1M

## AVAS-212 Video Stream Connecting Architecture

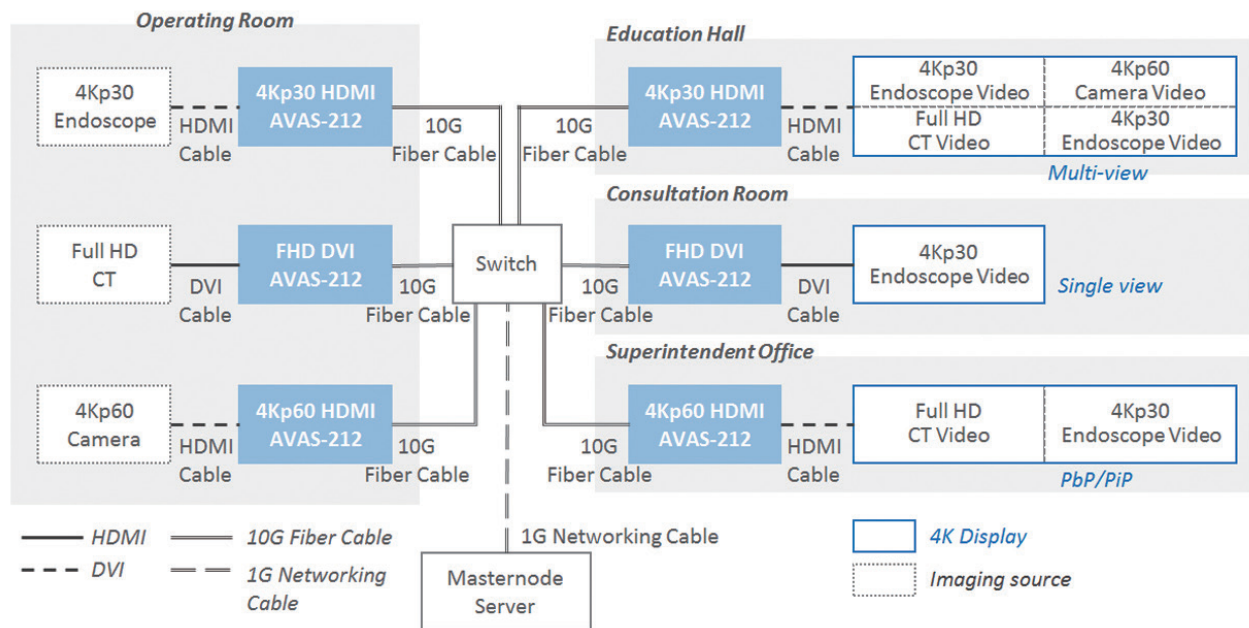

# Tento produkt můžete zakoupit u společnosti AutoCont IPC a.s.



## AutoCont IPC a.s.

Váš dodavatel průmyslových počítačů, komponent a speciálních průmyslových IT systémů.

 Uhlířská 1064/3, 710 00 Ostrava, Česká republika

 obchod@autocont-ipc.cz

 +420 552 301 002

 [www.autocont-ipc.cz](http://www.autocont-ipc.cz)



### PRŮMYSLOVÉ POČÍTAČE

*fanless embedded PC, do racku, ...*



### POČÍTAČE S DISPLEJEM

*panelové PC, terminály, do vozidel, ...*



### AUTOMATIZACE A SBĚR DAT

*převodníky, karty, moduly, switche, ...*



### PERIFERIE A KOMPONENTY

*monitory, klávesnice, desky, skříně, ...*



### NOTEBOOKY A TABLETY

*odolné, windows, android, IP65, ...*



### INFORMAČNÍ KIOSKY

*interiérové, venkovní, ...*



### MEDICÍNSKÁ TECHNIKA

*počítače, tablety, LCD, klávesnice, ...*



### SOFTWAREVÁ ŘEŠENÍ

*pro výrobu, zaměstnance, kiosky, ...*



### PŘEJÍT DO E-SHOPU

[eshop.autocont-ipc.cz](http://eshop.autocont-ipc.cz)



### DOPRAVA ZDARMA

Doprava zdarma v ČR a SR při objednávce nad 10 000 Kč bez DPH nebo nad 400 EUR.



### PRODLOUŽENÁ ZÁRUKA

Záruka 2 roky na vyráběné počítače s možností jejího prodloužení až na 5 let.



### ODMĚNA ZA VĚRNOST

Pravidelní zákazníci u nás nakupují za nižší ceny. Výše slevy se odvíjí od realizovaného obrátu.



### SERVIS ON-SITE A IN-TIME

K projektovým dodávkám nabízíme rozšířenou podporu a servis s garancí výměny zařízení do 48 hodin.