

AiMC-3202

**Micro Computer with
Intel® Core™ i7/i5/i3 Processor,
Intel® H110 Chipset, 2 x Expansion
Slots, and 250W 80PLUS PSU**



Features

- Intel® 6th/7th Gen Core™ i7/i5/i3/Celeron® processor with Intel® H110 chipset
- 1 x PCIe x16 and 1 x PCIe x4(1 x PCI for AIMC-3202-01) expansion slots
- Compact design with front-accessible I/O
- 1 x VGA+DVI-D, 2 x GbE LAN, 3 x USB 3.0, 2 x COM
- 2 x 2.5" internal, shock-resistant SATA HDD bays
- Supports chassis intrusion alerts
- 250W 80PLUS PSU offers energy savings



Specifications

Processor	CPU	i7-7700	i5-7500	i3-7101E	i7-7700T	i5-7500T	i3-7101TE	i7-6700	i5-6500	i3-6100	i7-6700TE	i5-6500TE	i3-6100TE	G4400TE	G3900TE	
	Core	4	4	2	4	4	2	4	4	2	4	4	2	2	2	
	Base Frequency	3.6 GHz	3.4 GHz	3.9 GHz	2.9 GHz	2.7 GHz	3.4 GHz	3.4 GHz	3.2 GHz	3.7 GHz	3.7 GHz	2.4 GHz	2.3 GHz	2.7 GHz	2.9 GHz	2.6 GHz
	L3 Cache	8 MB	6 MB	3 MB	8 MB	6 MB	3 MB	8 MB	6 MB	4 MB	8 MB	6 MB	4 MB	3 MB	2 MB	2 MB
	TDP	65W	65W	65W	35W	35W	35W	65W	65W	65W	65W	35W	35W	35W	35W	35W
	Chipset	Intel® H110														
	BIOS	AMI 128Mb SPI Flash														
Memory	Technology	Dual-channel DDR4 1866/2133 MHz (non-ECC)														
	Max. Capacity	32 GB (16 GB per DIMM)														
	Socket	2 x 260-pin SODIMM														
Graphics	Integrated Chipset	Intel® HD Graphics														
Ethernet	Interface	2 x RJ45, 10/100/1000 Mbps														
	Controller	LAN 1: Intel® i219V LAN 2: Intel® i211AT														
Expansion Slots (AIMC-3202-00)	PCI Express x16	1 (Upper-layer slot); full height: 111.15 mm, length: max. 175mm														
	PCI Express x4	1 (lower-layer slot); full height: 111.15 mm, length: max. 175mm with 1U cooler														
Expansion Slots (AIMC-3202-01)	PCI Express x16	1 (lower-layer slot); full height: 111.15 mm, length: max. 175mm with 1U cooler														
	PCI	1 (Upper-layer slot); full height: 111.15 mm, length: max. 175mm														
SATA	Data Transfer Rate	600 MB/s (SATA 3.0)														
	HDD Bay	2 x 2.5" internal SATA HD (height: Max 9mm (upper layer), 15mm (lower layer))														
	mSATA	1														
I/O Interface	Display	VGA+DVI-D (1920 x 1200 pixel @ 60Hz)														
	USB	3 x USB 3.0, 1 x USB 2.0 internal type-A for software key														
	Serial	2 x RS-232														
	PS/2	1														
Watchdog Timer	Output	System reset														
	Interval	Programmable 1 ~ 255 sec/min														
Power Supply	Output Rating	AC 250W, ATX														
	Input Voltage	100 ~ 240 V _{AC}														
Cooling	System Fan	2 (6 cm/14.1CFM)														
	Air Filter	Yes														
Miscellaneous	Chassis Intrusion Alert	Yes														
	LED Indicators	Power, HDD														
	Control	Power on/off switch														
Environment	Temperature	Operating										Non-operating				
		0 ~ 40 °C (32 ~ 104 °F)										-20 ~ 60 °C (-4 ~ 140 °F)				
	Humidity	10-85% @ 40 °C non-condensing										10-95% @ 40 °C non-condensing				
	Vibration	1Gms, random, 5 ~ 500 Hz, 3 axes, 1 hr/axis										2Gms, random, 5 ~ 500 Hz, 3 axes, 1 hr/axis				
	Shock	10G, half sine wave, 11ms duration														
	EMC	CE/FCC Class A, CCC, BSMI														
	Safety	UL/CB, CCC, BSMI														
Physical Characteristics	Dimensions (W x H x D)	232 x 90 x 232 mm (9.13" x 3.54" x 9.13")														
	Weight	4.5 kg														

Configuration table for CPU OS and CPU cooler

TDP	65W		35W	
CPU Generation	Intel 7th Kabylake	Intel 6th Skylake	Intel 7th Kabylake	Intel 6th Skylake
CPU	i7-7700 i5-7500 i3-7101E	i7-6700 i5-6500 i3-6100	i7-7700T i5-7500T i3-7101TE	i7-6700TE i5-6500TE i3-6100TE G4400TE G3900TE
OS Support	<ul style="list-style-type: none"> Win10 IoT Enterprise (64-bit) Linux 	<ul style="list-style-type: none"> Win10 IoT Enterprise (64-bit) Win 8.1 Pro Win 7 Professional Linux 	<ul style="list-style-type: none"> Win10 IoT Enterprise (64-bit) Linux 	<ul style="list-style-type: none"> Win10 IoT Enterprise (64-bit) Win 8.1 Pro Win 7 Professional Linux
CPU Cooler	1960053207N001(1.5U)		1960053207N001(1.5U) 1970004537N001 (1U)	

Fan Comparison Table

CPU Cooler	1970004537N001 (1U)	1960053207N001 (1.5U)
RPM	5500	4400
dB	55	43
CFM	11.83	45.09
System Expansion support	2*	2**
System Fan	98R1320200E	98R1320210E
RPM	3000	4500
dB	24.5	27
CFM	14.1	23.5
Dimension	60x60x20 mm	60x60x25mm

* Lower layer card max thickness: 12.97mm

** Lower layer card max length: 68mm

CPU Cooler (1U) : 1970004537N001

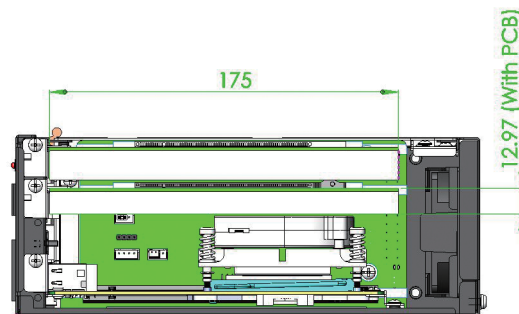
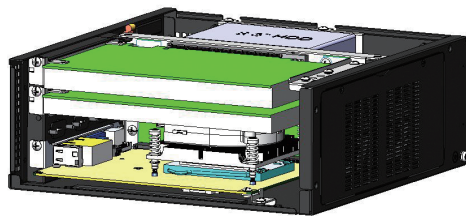

CPU Cooler (1.5U) : 1960053207N001

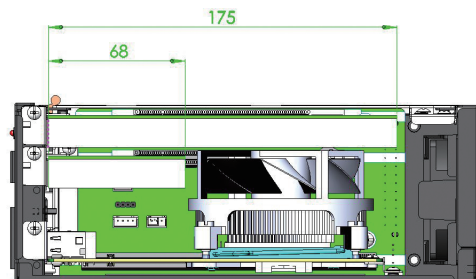
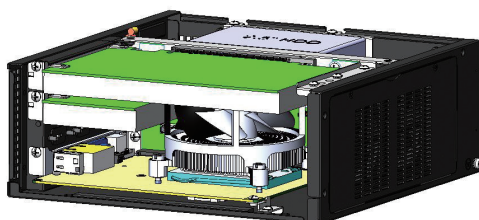

Dimensions

Unit: mm [inch]

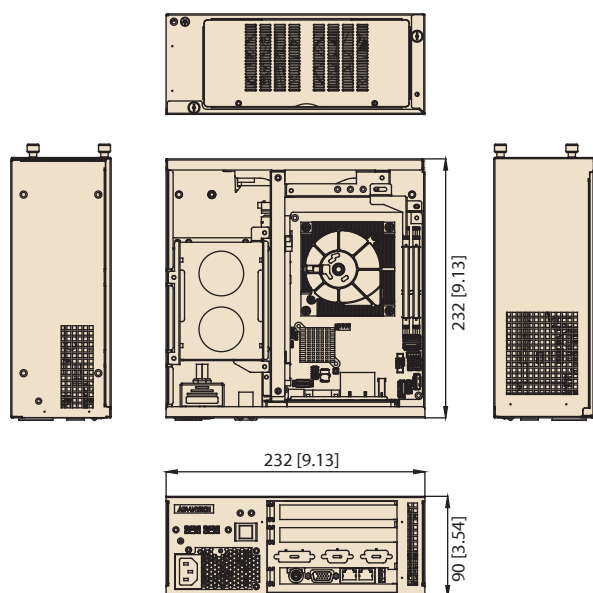

Installation

Unit: mm [inch]

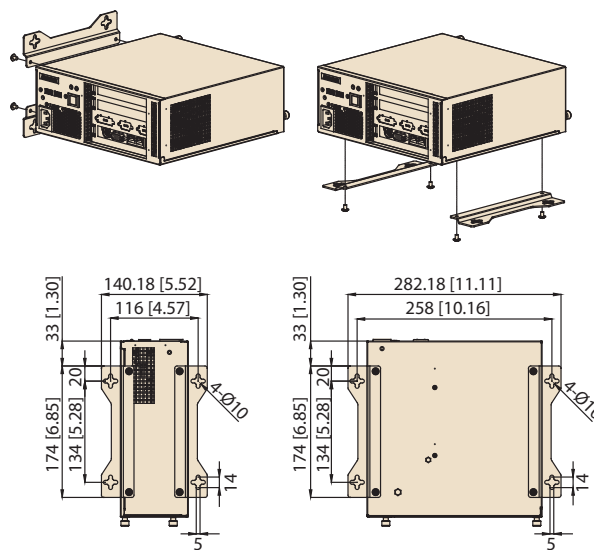

Front View

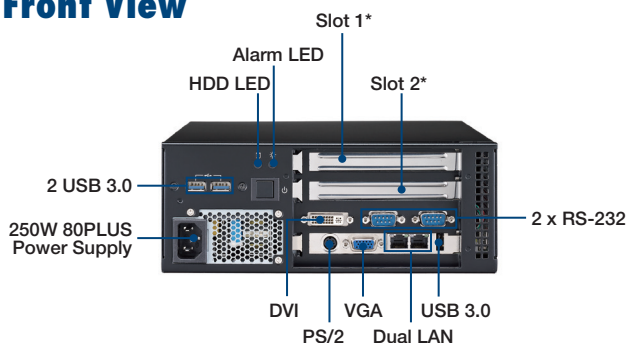

Rear cover for easy fan replacement

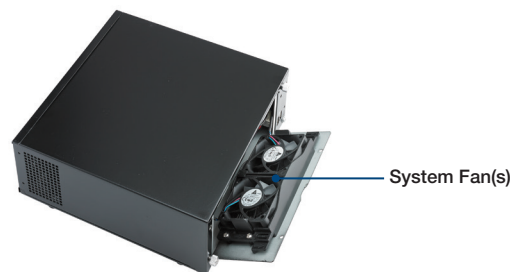

Ordering information

Part Number	VGA	DVI	USB 3.0	GbE	RS-232	PS/2	PSU	PCIe	PCI	Cooler
AiMC-3202-10B1	1	1	3	2	2	1	250W	Slot 1 (x16) Slot 2 (x4)	-	1.5U/1U
AiMC-3202-11B1	1	1	3	2	2	1	250W	Slot 2 (x16)	Slot 1	1.5U/1U

Packing List

Part Number	Description	Quantity
AiMC-3202-1xB1	AiMC-3202 bare system	1
2061302902	Driver CD	1
1700003194	SATA cable	1
1700022749-11	SATA power cable	1
9689000002	Jumper pack	1
1700060202	PS/2 cable	1
1960014487T001	Mounting brackets	2
1990008871S000	2.5 HDD rubber	4
1990012452S000	Rubber Foot	4
1960056953N000	Hold down Bar Bracket	1
1700002223	LTP cable	1
2001320200	Startup manual(EN+CH)	1

Optional Accessories

Part Number	Description
1960053207N001	1.5U cooler for all CPUs
1970004537N001	1U Cooler for 35W CPU
PCA-COM485-00A1E	4-port RS-485/422 module by LPC
PCA-COM232-00A1E	4-port RS-232 module by LPC
PCA-AUDIO-HDA1E	Audio extension module with HD audio interface
PCA-TPM-00A1E	Trusted platform module compliant with TCG 1.2
PCA-TPM-00B1E	Trusted platform module compliant with TCG 2.0
98R1320210E	6025 fan module
98R1320200E	6020 fan module
1990005760T00B	Fan 70* 2 Filter

Note: Customers must use the Advantech proprietary CPU cooler. Other brands of CPU coolers are NOT compatible.

Embedded OS

Part Number	Description
2070015046	WES7P x64 10MUI
20706WE7ES0015	WES7E x64 4MUI

Tento produkt můžete zakoupit u společnosti AutoCont IPC a.s.



AutoCont IPC a.s.

Váš dodavatel průmyslových počítačů, komponent a speciálních průmyslových IT systémů.

 Uhlířská 1064/3, 710 00 Ostrava, Česká republika

 obchod@autocont-ipc.cz

 +420 552 301 002

 www.autocont-ipc.cz



PRŮMYSLOVÉ POČÍTAČE

fanless embedded PC, do racku, ...



POČÍTAČE S DISPLEJEM

panelové PC, terminály, do vozidel, ...



AUTOMATIZACE A SBĚR DAT

převodníky, karty, moduly, switche, ...



PERIFERIE A KOMPONENTY

monitory, klávesnice, desky, skříně, ...



NOTEBOOKY A TABLETY

odolné, windows, android, IP65, ...



INFORMAČNÍ KIOSKY

interiérové, venkovní, ...



MEDICÍNSKÁ TECHNIKA

počítače, tablety, LCD, klávesnice, ...



SOFTWAREVÁ ŘEŠENÍ

pro výrobu, zaměstnance, kiosky, ...



PŘEJÍT DO E-SHOPU

eshop.autocont-ipc.cz



DOPRAVA ZDARMA

Doprava zdarma v ČR a SR při objednávce nad 10 000 Kč bez DPH nebo nad 400 EUR.



PRODLOUŽENÁ ZÁRUKA

Záruka 2 roky na vyráběné počítače s možností jejího prodloužení až na 5 let.



ODMĚNA ZA VĚRNOST

Pravidelní zákazníci u nás nakupují za nižší ceny. Výše slevy se odvíjí od realizovaného obrátu.



SERVIS ON-SITE A IN-TIME

K projektovým dodávkám nabízíme rozšířenou podporu a servis s garancí výměny zařízení do 48 hodin.