

i-Module Series

Expansion Module for MIC-7 Series







Features





- Flexible expansion via PCIe/PCI slot
- MIC-7 series compatible
- Optional smart fan for thermal optimization
- Provide additional 12Vdc power source for add-on card
- Maximum 85W for add-on card power consumption
- Support 250W power consumption GPU card by GPU i-Module
- Expansion for 2.5" HDD/SSD bay
- Swappable HDD/SSD supported

Introduction

MIC i-Module Series provide flexible expansion function for MIC-7 Series system. MIC i-Module Series support PCIe/PCI I/F add-on card, such as frame grabber, GPU and motion control cards, etc.. Except for the power from PCIe/PCI slot, i-Module reserves additional 12VDC power via the on-board connector for cards that need more power. To better control over the heat generated from add-on cards, optional system fans are supported with intelligent Smart Fan feature for better thermal management. With additional HDD/SSD bays in i-Module, customer can have more rooms for massive data storage. Removable storage bays are also supported.

Compatible Table

i-Module	1-slot		2-slot	
	MIC-75M10	MIC-75M20	MIC-75M20-01	MIC-75M11
MIC-7 System				
MIC-7300	✓	✓	✓	✓
MIC-7500	✓	✓	✓	✓
MIC-770Q/7700Q	✓	✓	✓	✓
MIC-770H/7700H	✓	✓	—	✓
MIC-7900	✓	✓	✓	✓

i-Module	4-slot		Featured	
	MIC-75M40	MIC-75M13	MIC-75S20	MIC-75G20
MIC-7 System				
MIC-7300	—	✓	✓	—
MIC-7500	✓	✓	✓	✓
MIC-770Q/7700Q	✓	✓	✓	✓
MIC-770H/7700H	—	✓	✓	✓
MIC-7900	✓	✓	✓	✓

Selection Table

i-Module slot number starts from the inner side, as the image on the right.

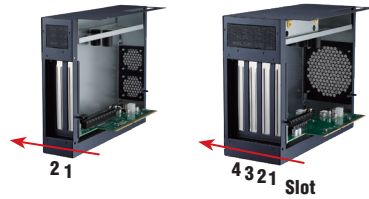

i-Module	MIC-75M10	MIC-75M11	MIC-75M20	MIC-75M20-01	MIC-75M40	MIC-75M13	MIC-75S20	MIC-75G20
Slot 1	PCIe x16*	PCIe x16*	PCIe x4*	PCIe x8*	PCIe x4	PCIe x16*	PCIe x16*	PCIe x4
Slot 2	-	PCI	PCIe x16*	PCIe x8*	PCIe x8	PCI	PCIe x4*	-
Slot 3	-	-	-	-	PCIe x4	PCI	-	PCIe x16
Slot 4	-	-	-	-	PCIe x4	PCI	-	-
SATA Port	-				1			
SATA PWR	-				1			
2.5" HDD/SSD Bay	-	1**			2		2 x Swappable + 2 x Internal	2 x Swappable
N.W. (kg)	0.64	0.87			1.16		1.60	2.99
G.W. (kg)	1.71	2.02			2.47		2.98	4.79
i-Module (W x H x D)	24 x 192 x 230		50 x 192 x 230		90 x 192 x 230		110 x 192 x 350	
MIC-7000 + i-Module (W x H x D)	97 x 192 x 230		123 x 192 x 230		163 x 192 x 230		184 x 192 x 350	
MIC-77X + i-Module (W x H x D)	101 x 192 x 230		127 x 192 x 230		167 x 192 x 230		187 x 192 x 350	
System Fan	-	98R1752000E (Optional)***			98R1751300E (Optional)***		Embedded	
12V _{DC} Conn				1				
12V _{DC} Conn. for GPU				-		2		
PCI/PCIe Card Max. Length (with fan)	190.2 mm					184.75 mm		287.35 mm
PCI/PCIe Card Max. Length (without fan)				210.4 mm				

* If install on MIC-7300, this slot is PCIe x1 signal.

** Need to order 98R1752010E (2.5" HDD/SSD kit for 2-slot i-Module)

*** Suggest to add optional system fan if power consumption of add-on card is more than **45W** for better thermal management.

Dimension Guide

i-Module Width: 90 mm

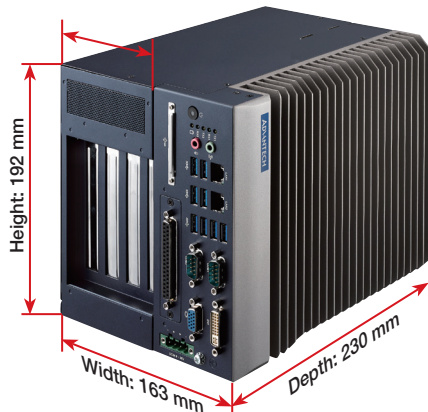

i-Module Add-on card Dimension Guide

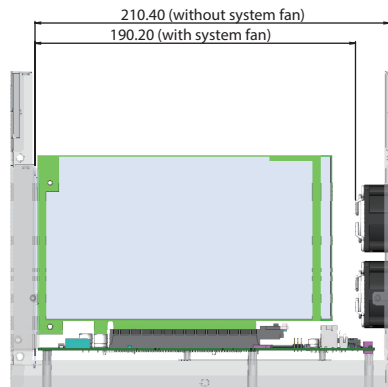

2-slot i-Module

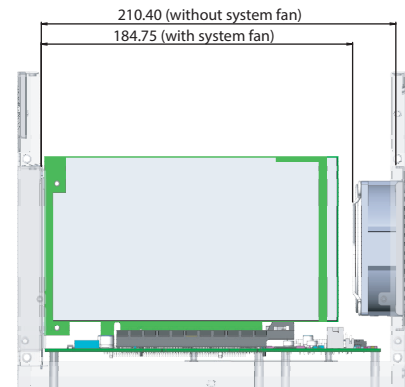

4-slot i-Module

Example: MIC-7500 + MIC-75M40
Using MIC-77xx, width will be increased by 4mm.

MIC-75G20 GPU card Dimension Guide

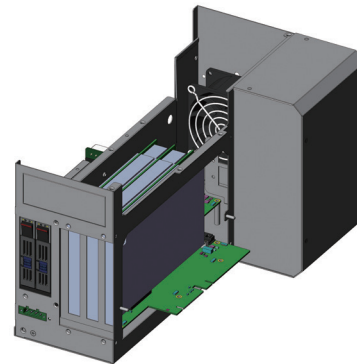
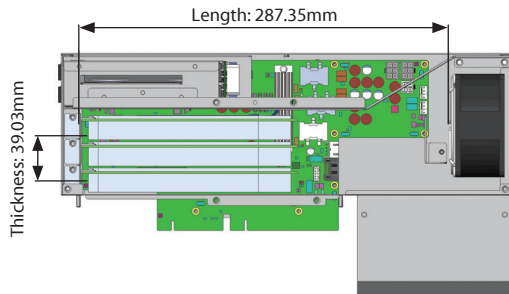

2.5" HDD/SSD Bay Support Table

Every MIC-7 Series can support one HDD/SSD bay in system. With i-Module added, the total 2.5" HDD/SSD bay quantity as below.

MIC-7 Series	MIC-7300	MIC-7500	MIC-7700		MIC-770		MIC-7900
			MIC-7700Q	MIC-7700H	MIC-770Q	MIC-770H	
SATA Port in system	1	1	3	1	3	1	4
2.5" HDD/SSD bay in MIC				1			
Total 2.5" HDD/SSD Bay with i-Module added	MIC-75M20						
	MIC-75M20-01				1 / 2*		
	MIC-75M11						
	MIC-75M40	2	2	3	2	3	2
	MIC-75M13	2	2	3	2	3	2
MIC-75S20	2	2	4	2	4	2	5
MIC-75G20	-	2	3	2	3	2	3

* Need to order 98R1752010E (2.5" HDD/SSD kit for 2-slot i-Module)

Note: i-Module BUS has only one channel SATA signal between i-Module and MIC-7 system.

2.5" HDD/SSD kit for 2-slot i-Module

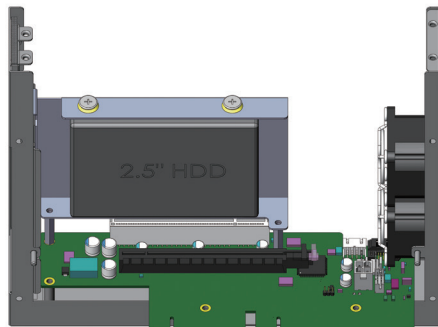

2.5" HDD/SSD Thickness Guide

Swappable HDD/SSD Supportable i-Module: MIC-75S20 (Maximum 15mm 2.5" HDD/SSD)

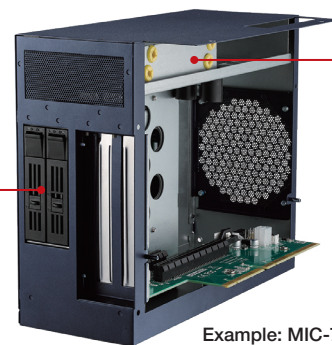

Internal HDD/SSD Supportable i-Module: MIC-75M40, MIC-75M13, MIC-75S20 (Support 1x 15mm 2.5" or 2x 9.6mm 2.5" HDD/SSD)

Example: MIC-75S20

Ordering information: 98R1752010E

Supportable i-Module: MIC-75M20, MIC-75M20-01, MIC-75M11

Limitation: Slot 2 will be occupied

Ordering Information

Part Number	Description
MIC-75M13-00A1E	4-slot expansion i-Module with 1 PCIe x16, 3 PCI
MIC-75M40-00A1E	4-slot expansion i-Module with 1 PCIe x8, 3 PCIe x4
MIC-75M11-00A1E	2-slot expansion i-Module with 1 PCIe x16, 1 PCI
MIC-75M20-00B1	2-slot expansion i-Module with 1 PCIe x16, 1 PCIe x4
MIC-75M20-01A1E	2-slot expansion i-Module with 2 PCIe x8
MIC-75M10-00A1	1-slot expansion i-Module with 1 PCIe x16
MIC-75S20-00A1E	2-slot expansion i-Module with 1 PCIe x16, 1 PCIe x4, 2 x 2.5" swappable HDD/SSD bay
MIC-75G20-00A1*	GPU card expansion i-Module with 1 PCIe x16, 1 PCIe x4, 2 x 2.5" swappable HDD/SSD bay

* Please refer to MIC-75G20 datasheet for more product information.

Optional Accessories

Part Number	Description
98R1751300E	8-cm fan for 4-slot i-Modules
98R1752000E	2 x 4-cm fan for 2-slot i-Modules
98R1752010E	2.5" HDD/SSD kit for 2-slot i-Module
1700024858-01	4-pin 12V _{DC} power cable (15cm)
MIC-75G20*	
96PSD-A480W24-MN	480W PSU
1700029474-01	PSU Y-type cable (1.5M)
1700029720-01	PSU power cord (USA) UL/CSA (1.83M)
1700022074-11	4-pin 12V _{DC} power cable (40cm)

Tento produkt můžete zakoupit u společnosti AutoCont IPC a.s.



AutoCont IPC a.s.

Váš dodavatel průmyslových počítačů, komponent a speciálních průmyslových IT systémů.

 Uhlířská 1064/3, 710 00 Ostrava, Česká republika

 obchod@autocont-ipc.cz

 +420 552 301 002

 www.autocont-ipc.cz



PRŮMYSLOVÉ POČÍTAČE

fanless embedded PC, do racku, ...



POČÍTAČE S DISPLEJEM

panelové PC, terminály, do vozidel, ...



AUTOMATIZACE A SBĚR DAT

převodníky, karty, moduly, switche, ...



PERIFERIE A KOMPONENTY

monitory, klávesnice, desky, skříně, ...



NOTEBOOKY A TABLETY

odolné, windows, android, IP65, ...



INFORMAČNÍ KIOSKY

interiérové, venkovní, ...



MEDICÍNSKÁ TECHNIKA

počítače, tablety, LCD, klávesnice, ...



SOFTWAREVÁ ŘEŠENÍ

pro výrobu, zaměstnance, kiosky, ...



PŘEJÍT DO E-SHOPU

eshop.autocont-ipc.cz



DOPRAVA ZDARMA

Doprava zdarma v ČR a SR při objednávce nad 10 000 Kč bez DPH nebo nad 400 EUR.



PRODLOUŽENÁ ZÁRUKA

Záruka 2 roky na vyráběné počítače s možností jejího prodloužení až na 5 let.



ODMĚNA ZA VĚRNOST

Pravidelní zákazníci u nás nakupují za nižší ceny. Výše slevy se odvíjí od realizovaného obrátu.



SERVIS ON-SITE A IN-TIME

K projektovým dodávkám nabízíme rozšířenou podporu a servis s garancí výměny zařízení do 48 hodin.