

Advantech

AQD-D4U16GN32-SE Datasheet

Rev. 0.0

2020-07-17

Description

AQD-D4U16GN32-SE is a DDR4 3200Mbps U-DIMM high-speed, memory module that use 16pcs of 1024Mx 8 bits DDR4 SDRAM in FBGA package and a 4K bits serial EEPROM on a 288-pin printed circuit board.

AQD-D4U16GN32-SE is a Dual In-Line Memory Module and is intended for mounting into 288-pin edge connector sockets.

Synchronous design allows precise cycle control with the use of system clock. Data I/O transactions are possible on both edges of DQS. Range of operation frequencies, programmable latencies allow the same device to be useful for a variety of high bandwidth, high performance memory system applications.

Features

- RoHS compliant products.
- JEDEC standard 1.2V(1.14V~1.26V) Power supply
VDDQ= 1.2V(1.14V~1.26V)
- VPP = 2.5V +0.25V / -0.125V
- Data transfer rates: PC4-3200
Programmable CAS Latency:11,12,13,14,15,16,17~22
- 8 bit pre-fetch
- Burst Length (BL) switch on-the-fly BL8 or BC4
- Bi-directional Differential Data-Strobe
- On Die Termination, Nominal, Park, and Dynamic ODT
- Serial presence detect with EEPROM
Asynchronous reset
PCB edge connector treated with 30u" Gold-Plating
- Anti - sulfur resistor used

Pin Identification

Symbol	Function
A0~A17 ¹ , BA0~BA1	Address/Bank input
DQ0~DQ63	Bi-direction data bus.

DQS0_t~DQS17_t	Data Buffer data strobes
DQS0_c~DQS17_c	Data Buffer data strobes
CK0_t, CK1_t	SDRAM clocks
CK0_c, CK1_c	SDRAM clocks
ODT0 &ODT1	On-die termination control line
CS0_n~CS3_n	DIMM Rank Select Lines input.
RAS_n ²	Row address strobe
CAS_n ³	Column address strobe
WE_n ⁴	Write Enable
DM0~DM7	Data masks/high data strobes
VDD	Core power supply
VDDQ	I/O driver power supply
V _{REFCA}	Command/address reference supply
V _{DDSPD}	SPD EEPROM power supply
SA0~SA2	I2C serial bus address select for EEPROM
SCL	I2C serial bus clock for EEPROM
SDA	I2C serial bus data for EEPROM
VSS	Ground
RESET_n	Set DRAMs Known State
VTT	DRAM I/O termination supply
VPP	SDRAM Supply
ALERT_n	SDRAM ALERT_n
EVENT_n	SPD signals a thermal event has occurred
RFU	Reserved for future use

1. Address A17 is not valid for x8 and x16 based SDRAMs. For UDIMMs this connection pin is NC.

2. RAS_n is a multiplexed function with A16.

3. CAS_n is a multiplexed function with A15.

4. WE_n is a multiplexed function with A14.

Dimensions (Unit: millimeter)

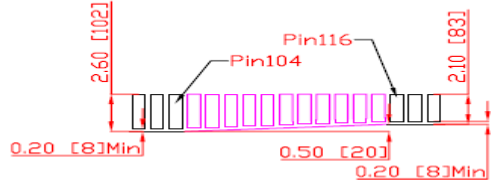
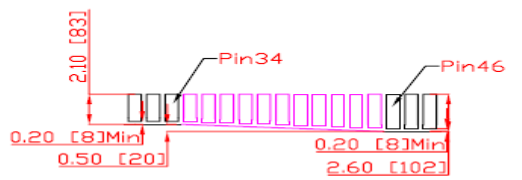
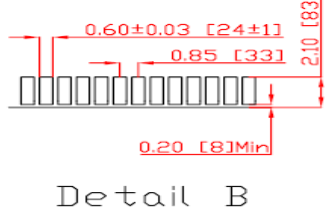
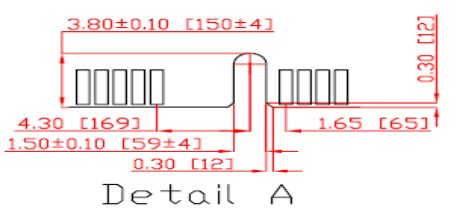
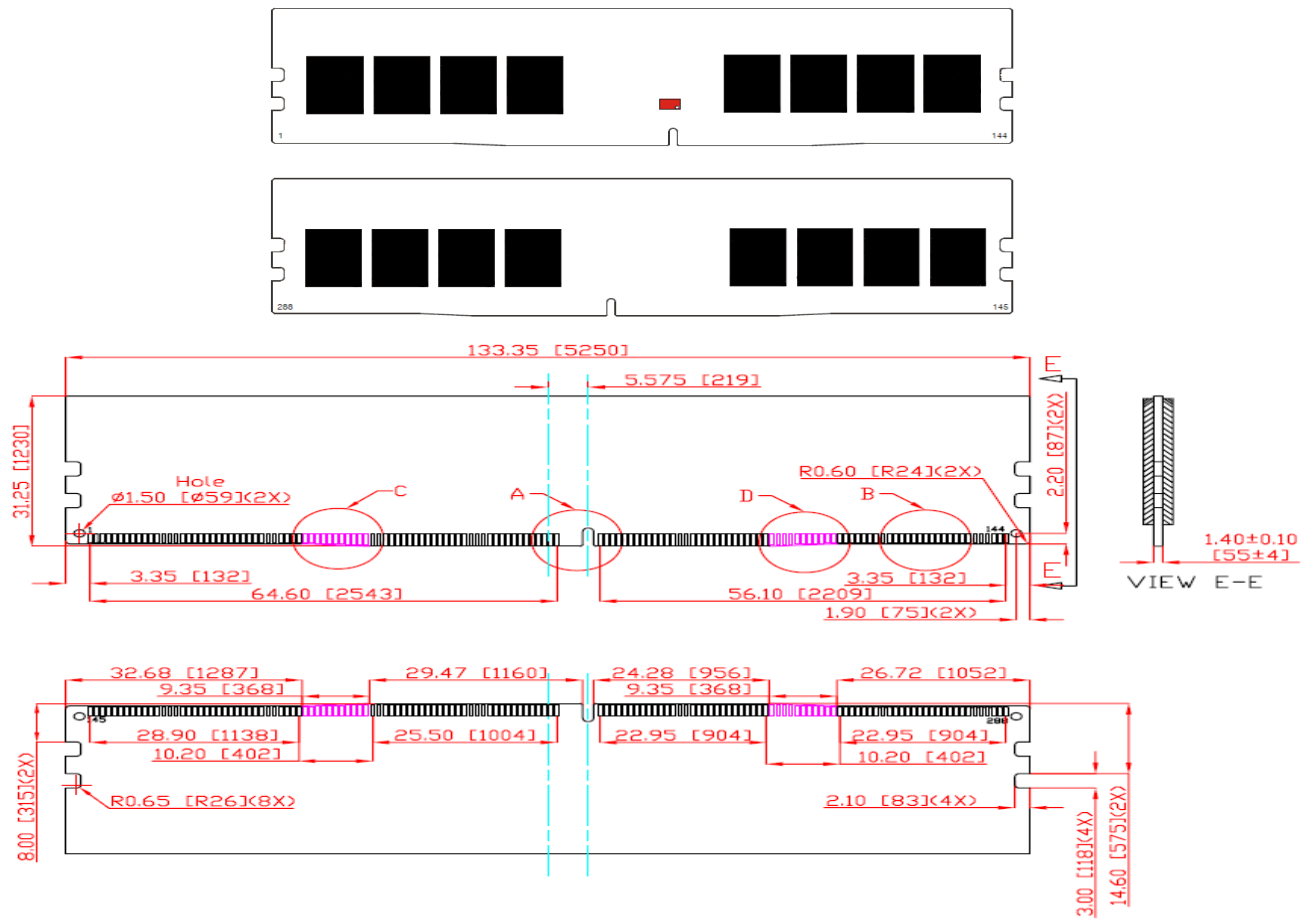

Note:1. Tolerances on all dimensions +/-0.15mm unless otherwise specified.



Enabling an Intelligent Planet

288Pin DDR4 3200 1.2V U-DIMM

16GB Based on 1024Mx8

AQD-D4U16GN32-SE

Pin Assignments

Pin	Front	Pin	Front	Pin	Front	Pin	Back	Pin	Back	Pin	Back	Pin	Back	Pin	Back
1	12V	41	NC	81	BA0	121	DM6,DBI6	161	DQ9	201	CB3	241	VSS	281	VSS
2	VSS	42	VSS	82	RAS_n/A16	122	NC	162	VSS	202	VSS	242	DQ33	282	DQ59
3	DQ4	43	DQ30	83	VDD	123	VSS	163	DQS1C	203	CKE1	243	VSS	283	VSS
4	VSS	44	VSS	84	CS0_n	124	DQ54	164	DQS1T	204	VDD	244	DQS4C	284	VDDSPD
5	DQ0	45	DQ26	85	VDD	125	VSS	165	VSS	205	RFU	245	DQS4T	285	SDA
6	VSS	46	VSS	86	CAS_n/A15	126	DQ50	166	DQ15	206	VDD	246	VSS	286	VPP
7	DM0,DBI0	47	CB4	87	ODT0	127	VSS	167	VSS	207	BG1	247	DQ39	287	VPP
8	NC	48	VSS	88	VDD	128	DQ60	168	DQ11	208	ALERT_n	248	VSS	288	VPP
9	VSS	49	CB0	89	CS1_n	129	VSS	169	VSS	209	VDD	249	DQ35		
10	QD6	50	VSS	90	VDD	130	DQ56	170	DQ21	210	A11	250	VSS		
11	VSS	51	DM8,DBI8	91	ODT1	131	VSS	171	VSS	211	A7	251	DQ45		
12	DQ2	52	NC	92	VDD	132	DM7,DBI7	172	DQ17	212	VDD	252	VSS		
13	VSS	53	VSS	93	NC	133	NC	173	VSS	213	A5	253	DQ41		
14	DQ12	54	CB6	94	VSS	134	VSS	174	DQS2C	214	A4	254	VSS		
15	VSS	55	VSS	95	DQ36	135	DQ62	175	DQS2T	215	VDD	255	DQS5C		
16	DQ8	56	CB2	96	VSS	136	VSS	176	VSS	216	A2	256	DQS5T		
17	VSS	57	VSS	97	DQ32	137	DQ58	177	DQ23	217	VDD	257	VSS		
18	DM1,DBI1	58	RESET_n	98	VSS	138	VSS	178	VSS	218	CK1T	258	DQ47		
19	NC	59	VDD	99	DM4,DBI4	139	SA0	179	DQ19	219	CK1C	259	VSS		
20	VSS	60	CKE0	100	NC	140	SA1	180	VSS	220	VDD	260	DQ43		
21	DQ14	61	VDD	101	VSS	141	SCL	181	DQ29	221	VTT	261	VSS		
22	VSS	62	ACT_n	102	DQ38	142	VPP	182	VSS	222	PARITY	262	DQ53		
23	DQ10	63	BG0	103	VSS	143	VPP	183	DQ25	223	VDD	263	VSS		
24	VSS	64	VDD	104	DQ34	144	RFU	184	VSS	224	BA1	264	DQ49		
25	DQ20	65	A12/BC_n	105	VSS	145	12V	185	DQS3C	225	A10_AP	265	VSS		
26	VSS	66	A9	106	DQ44	146	VREFCA	186	DQS3T	226	VDD	266	DQS6C		
27	DQ16	67	VDD	107	VSS	147	VSS	187	VSS	227	RFU	267	DQS6T		
28	VSS	68	A8	108	DQ40	148	DQ8	188	DQ31	228	WE_n/A14	268	VSS		
29	DM2,DBI2	69	A6	109	VSS	149	VSS	189	VSS	229	VDD	269	DQ55		
30	NC	70	VDD	110	DM5,DBI5	150	DQ1	190	DQ27	230	NC	270	VSS		
31	VSS	71	A3	111	NC	151	VSS	191	VSS	231	VDD	271	DQ51		
32	DQ22	72	A1	112	VSS	152	DQS0C	192	CB5	232	A13	272	VSS		
33	VSS	73	VDD	113	DQ46	153	DQS0T	193	VSS	233	VDD	273	DQ61		
34	DQ18	74	CK0T	114	VSS	154	VSS	194	CB1	234	NC	274	VSS		
35	VSS	75	CK0C	115	DQ42	155	DQ7	195	VSS	235	NC	275	DQ57		
36	DQ28	76	VDD	116	VSS	156	VSS	196	DQS8C	236	VDD	276	VSS		
37	VSS	77	VTT	117	DQ52	157	DQ3	197	DQS8T	237	NC	277	DQS7C		
38	DQ24	78	EVENT_n	118	VSS	158	VSS	198	VSS	238	SA2	278	DQS7T		
39	VSS	79	A0	119	DQ48	159	DQ13	199	CB7	239	VSS	279	VSS		
40	DM3,DBI3	80	VDD	120	VSS	160	VSS	200	VSS	240	DQ37	280	DQ63		

16GB, 1Gx8 Module (2 Rank x8)

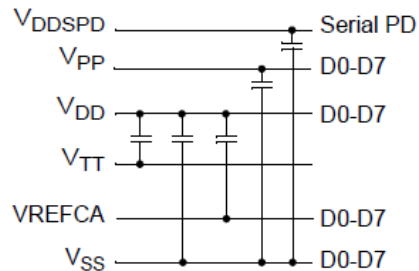
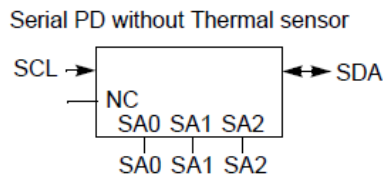
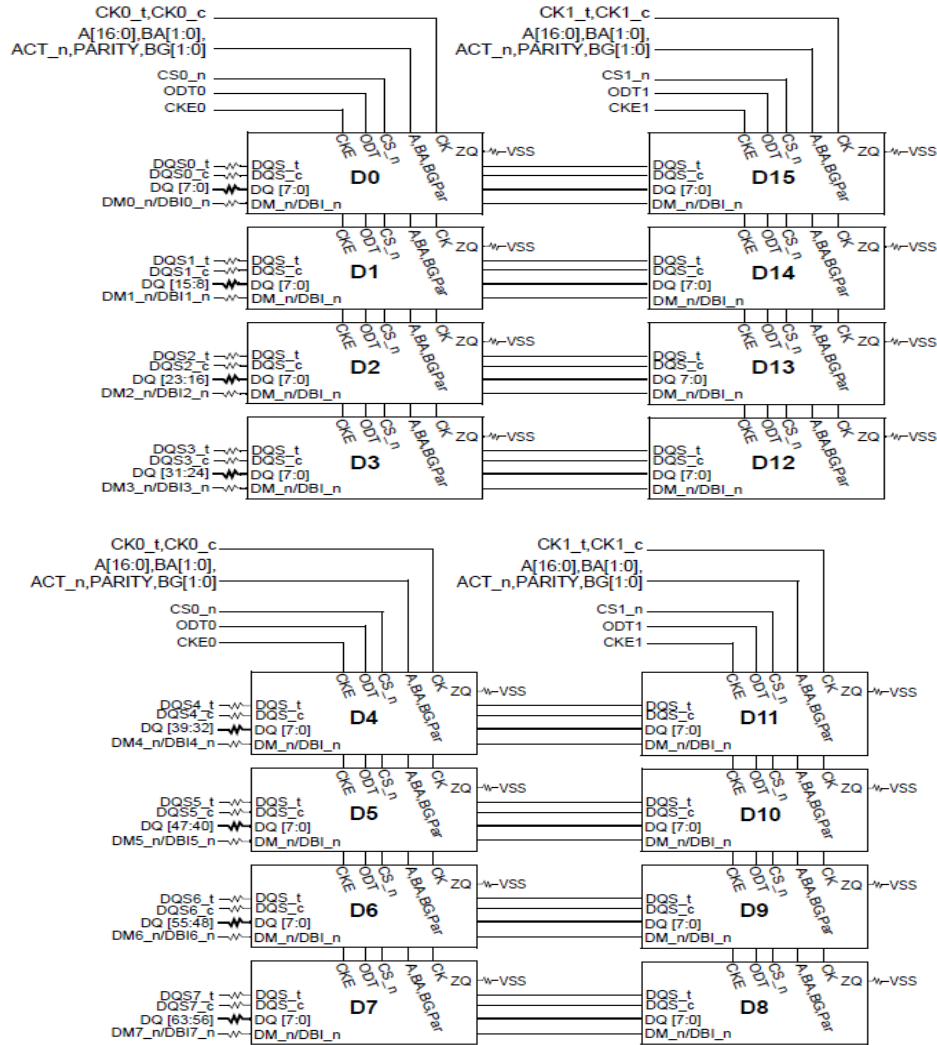

- This technical information is based on industry standard data and tests believed to be reliable. However, Advantech makes no warranties, either expressed or implied, as to its accuracy and assume no liability in connection with the use of this product. Advantech reserves the right to make changes in specifications at any time without prior notice.

Operating Temperature Condition

Parameter	Symbol	Rating	Unit	Note
Operating Temperature	TOPER	0 to 85	°C	1,2

Note: Operating Temperature is the case surface temperature on the center/top side of the DRAM. For the measurement conditions, please refer to JESD51-2 standard.

Absolute Maximum DC Ratings

Parameter	Symbol	Value	Unit	Note
Voltage on VDD relative to Vss	VDD	-0.3 ~ 1.5	V	1
Voltage on VDDQ pin relative to Vss	VDDQ	-0.3 ~ 1.5	V	1
Voltage on any pin relative to Vss	VIN, VOUT	-0.3 ~ 1.5	V	1
Storage temperature	TSTG	-55~+100	°C	1,2

Note: 1. Stress greater than those listed under “Absolute Maximum Ratings” may cause permanent damage to the device. This is a stress rating only and functional operation of the device at these or any other conditions above those indicated in the operational sections of this specification is not implied. Exposure to absolute maximum rating conditions for extended periods may affect reliability.
 2. Storage Temperature is the case surface temperature on the center/top side of the DRAM. For the measurement conditions, please refer to JESD51-2 standard.

AC & DC Operating Conditions

Recommended DC operating conditions

Parameter	Symbol	Voltage	Rating			Unit	Notes
			Min	Typ.	Max		
Supply voltage	VDD	1.2V	1.14	1.2	1.26	V	1,2,3
Supply voltage for Output	VDDQ	1.2V	1.14	1.2	1.26	V	1,2,3
I/O Reference Voltage (DQ)	VREF _{DQ} (DC)	1.2V	0.49*VDD	0.50*VDD	0.51*VDD	V	4
I/O Reference Voltage (CMD/ADD)	VREF _{CA} (DC)	1.2V	0.49*VDD	0.50*VDD	0.51*VDD	V	4
AC Input Logic High	V _{IH} (AC)	1.2V	VREF+90	-	VDD ²	mV	
AC Input Logic Low	V _{IL} (AC)	1.2V	VSS ²	-	VREF-90	mV	
DC Input Logic High	V _{IH} (DC)	1.2V	VREF+65	-	VDD	mV	
DC Input Logic Low	V _{IL} (DC)	1.2V	VSS	-	VREF-65	mV	

Note: (1) Under all conditions VDDQ must be less than or equal to VDD.
 (2) VDDQ tracks with VDD. AC parameters are measured with VDD and VDDQ tied together.
 (3) The DC bandwidth is limited to 20MHz.
 (4) The AC peak noise on VREF may not allow VREF to deviate from VREF(DC) by more than ±1% VDD (for reference: approx. ±12mV)

IDD Specification parameters Definition - 16GB (2 Rank x8)

Parameter	Symbol	DDR4 3200 CL22	Unit
One bank ACTIVATE-PRECHARGE current	IDD0 ¹	352	mA
One bank ACTIVATE-PRECHARGE, wordline boost, IPP current	IPP0 ¹	64	mA
One Bank Active-Read-Precharge Current	IDD1 ¹	376	mA
Precharge Standby Current	IDD2N ²	320	mA
Precharge standby ODT current	IDD2NT ¹	280	mA
Precharge Power-Down Current	IDD2P ²	208	mA
Precharge Quiet Standby Current	IDD2Q ²	320	mA
Active standby current	IDD3N ²	480	mA
Active standby IPP current	IPP3N ²	64	mA
Active Power-Down Current	IDD3P ²	336	mA
Burst Read Current	IDD4R ¹	1016	mA
Burst write current	IDD4W ¹	952	mA
Burst refresh current (1x REF)	IDD5B ¹	1944	mA
Burst refresh IPP current (1x REF)	IPP5B ¹	232	mA
Self refresh current: Normal temperature range (0–85°C)	IDD6N ²	336	mA
Self refresh current: Extended temperature range (0–95°C)	IDD6E ²	512	mA
Bank interleave read current	IDD7 ¹	1368	mA
Bank interleave read IPP current	IPP7 ¹	120	mA
Maximum power-down current	IDD8 ²	176	mA

Note: 1. One module rank in the active IDD/PP, the other rank in IDD2P/PP3N.
 2. All ranks in this IDD/PP condition.
 3. IDD current measure method and detail patterns are described on DDR4 component datasheet. Only for reference.

■ Timing Parameters & Specifications

Parameter	Symbol	DDR4-2400		DDR4-2666		DDR4-2933		DDR4-3200		Unit	Notes	
		Min	Max	Min	Max	Min	Max	Min	Max			
Clock Timing												
Clock period average(DLL off mode)	tCK(DLL_OFF)	8	20	8	20	8	20	8	20	ns		
Clock period average	tCK(AVG) (DLL_ON)	0.833	<0.938	0.75	<0.833	0.682	<0.75	0.625	<0.682	ns	14	
High pulse width average	tCH (AVG)	0.48	0.52	0.48	0.52	0.48	0.52	0.48	0.52	tCK(AVG)		
Low pulse width average	tCL (AVG)	0.48	0.52	0.48	0.52	0.48	0.52	0.48	0.52	tCK(AVG)		
Clock period jitter	Total	tJITper_tot	-42	42	-38	38	-34	34	-32	32	ps	18 , 19
	Deterministic	tJITper_dj	-21	21	-19	19	-17	17	-16	16	ps	18
	DLL locking	tJITper,lck	-33	33	-30	30	-27	27	-25	25	ps	
Clock absolute period	tCK (ABS)	MIN = tCK (AVG) MIN + tJITper_tot MIN; MAX = tCK (AVG) MAX + tJITper_tot MAX								ps		
Clock absolute high pulse width(includes duty cycle jitter)	tCH (ABS)	0.45	-	0.45	-	0.45	-	0.45	-	tCK(AVG)		
Clock absolute low pulse width(includes duty cycle jitter)	tCL (ABS)	0.45	-	0.45	-	0.45	-	0.45	-	tCK(AVG)		
Cycle-to-cycle jitter	Total	tJITcc_tot	-	83	-	75	-	68	-	62	ps	
	DLL locking	tJITcc,lck	-	67	-	60	-	55	-	50	ps	
Cumulative error across	2 cycles	tERR2per	-61	61	-55	55	-50	50	-46	46	ps	
	3 cycles	tERR3per	-73	73	-66	66	-60	60	-55	55	ps	
	4 cycles	tERR4per	-81	81	-73	73	-66	66	-61	61	ps	
	5 cycles	tERR5per	-87	87	-78	78	-71	71	-65	65	ps	
	6 cycles	tERR6per	-92	92	-83	83	-75	75	-69	69	ps	
	7 cycles	tERR7per	-97	97	-87	87	-79	79	-73	73	ps	
	8 cycles	tERR8per	-101	101	-91	91	-83	83	-76	76	ps	
	9 cycles	tERR9per	-104	104	-94	94	-85	85	-78	78	ps	
	10 cycles	tERR10per	-107	107	-96	96	-88	88	-80	80	ps	
	11 cycles	tERR11per	-110	110	-99	99	-90	90	-83	83	ps	
	12 cycles	tERR12per	-112	112	-101	101	-92	92	-84	84	ps	
	n=13,14...49, 50cycles	tERRnper	tERRnper MIN = (1 + 0.68ln[n]) × tJITper_tot MIN tERRnper MAX = (1 + 0.68ln[n]) × tJITper_tot MAX								ps	

Parameter		Symbol	DDR4-2400		DDR4-2666		DDR4-2933		DDR4-3200		Unit	Notes
			Min	Max	Min	Max	Min	Max	Min	Max		
DQ Input Timing												
Data setup time to DQS_t, DQS_c	Base(calibrated V_{REF})	tDS	Refer to DQ Input Receiver Specification section (approximately 0.15tCK to 0.28tCK)								-	
	Noncalibrated V_{REF}	tPDA_S	minimum of 0.5UI								UI	23
Data hold time from DQS_t, DQS_c	Base(calibrated V_{REF})	tDS	Refer to DQ Input Receiver Specification section (approximately 0.15tCK to 0.28tCK)								-	
	Noncalibrated V_{REF}	tPDA_S	minimum of 0.5UI								UI	23
DQ and DM minimum data pulse width for each input		tDIPW	0.58	-	0.58	-	0.58	-	0.58	-	UI	
DQ Output Timing (DLL enabled)												
DQS_t, DQS_c to DQ skew, per group, per access		tDQSQ	-	0.17	-	0.18	-	0.19	-	0.22	UI	
DQ output hold time from DQS_t, DQS_c		tQH	0.74	-	0.74	-	0.74	-	0.74	-	UI	
Data Valid Window per device: tQH -tDQSQ each device's output per UI		tDVWd	0.64	-	0.64	-	0.64	-	0.64	-	UI	
Data Valid Window per device, per pin: tQH - tDQSQ each device's output per UI		tDVWp	0.72	-	0.72	-	0.72	-	0.72	-	UI	
DQ Low-Z time from CK_t, CK_c		tLZDQ	-330	175	-310	170	-280	165	-250	160	ps	
DQ High-Z time from CK_t, CK_c		tHZDQ	-	175	-	170	-	165	-	160	ps	
DQ Strobe Input Timing												
DQS_t, DQS_c rising edge to CK_t, CK_c rising edge for 1tCKpreamble		tDQSS _{1ck}	-0.27	0.27	-0.27	0.27	-0.27	0.27	-0.27	0.27	CK	
DQS_t, DQS_c rising edge to CK_t, CK_c rising edge for 2tCKpreamble		tDQSS _{2ck}	-0.50	0.50	-0.50	0.50	-0.50	0.50	-0.50	0.50	CK	
DQS_t, DQS_c differential input low pulse width		tDQSL	0.46	0.54	0.46	0.54	0.46	0.54	0.46	0.54	CK	

Parameter	Symbol	DDR4-2400		DDR4-2666		DDR4-2933		DDR4-3200		Unit	Notes
		Min	Max	Min	Max	Min	Max	Min	Max		
DQ Strobe Input Timing											
DQS_t, DQS_c differential input high pulse width	tDQSH	0.46	0.54	0.46	0.54	0.46	0.54	0.46	0.54	CK	
DQS_t, DQS_c falling edge setup to CK_t, CK_c rising edge	tDSS	0.18	-	0.18	-	0.18	-	0.18	-	CK	
DQS_t, DQS_c falling edge hold from CK_t, CK_c rising edge	tDSH	0.18	-	0.18	-	0.18	-	0.18	-	CK	
DQS_t, DQS_c differential WRITE preamble for 1'CKpreamble	tWPRE _{1ck}	0.9	-	0.9	-	0.9	-	0.9	-	CK	
DQS_t, DQS_c differential WRITE preamble for 2'CKpreamble	tWPRE _{2ck}	1.8	-	1.8	-	1.8	-	1.8	-	CK	
DQS_t, DQS_c differential WRITE postamble	tWPST	0.33	-	0.33	-	0.33	-	0.33	-	CK	
DQS Strobe Output Timing (DLL enabled)											
DQS_t, DQS_c rising edge output access time from rising CK_t, CK_c	tDQCK	-175	175	-170	170	-165	165	-160	160	ps	
DQS_t, DQS_c rising edge output variance window per DRAM	tDQCKi	-	290	-	270	-	265	-	260	ps	
DQS_t, DQS_c differential output high time	tQSH	0.4	-	0.4	-	0.4	-	0.4	-	CK	
DQS_t, DQS_c differential output low time	tQSL	0.4	-	0.4	-	0.4	-	0.4	-	CK	
DQS_t, DQS_c Low-Z time (RL - 1)	tLZDQS	-330	175	-310	170	-280	165	-250	160	ps	
DQS_t, DQS_c High-Z time (RL + BL/2)	tHZDQS	-	175	-	170	-	165	-	160	ps	
DQS_t, DQS_c differential READ preamble for 1'CKpreamble	tRPRE _{1ck}	0.9	-	0.9	-	0.9	-	0.9	-	CK	
DQS_t, DQS_c differential READ preamble for 2'CKpreamble	tRPRE _{2ck}	1.8	-	1.8	-	1.8	-	1.8	-	CK	
DQS_t, DQS_c differential READ postamble	tRPST	0.33	-	0.33	-	0.33	-	0.33	-	CK	

Parameter	Symbol	DDR4-2400		DDR4-2666		DDR4-2933		DDR4-3200		Unit	Notes
		Min	Max	Min	Max	Min	Max	Min	Max		
Command and Address Timing											
DLL locking time	tDLLK	768	–	1024	–	1024	–	1024	–	CK	2, 4
CMD, ADDR setup time to CK_t, CK_c Base referenced to V _{IH(AC)} and V _{IL(AC)} levels	Base	tIS	62	–	55	–	48	–	40	–	ps
	V _{REFCA}	tISVREF	162	–	145	–	138	–	130	–	ps
CMD, ADDR hold time to CK_t, CK_c Base referenced to V _{IH(DC)} and V _{IL(DC)} levels	Base	tIH	87	–	80	–	73	–	65	–	ps
	V _{REFCA}	tIHVREF	162	–	145	–	138	–	130	–	ps
CTRL, ADDR pulse width for each input	tIPW	410	–	385	–	365	–	340	–	ps	
ACTIVATE to internal READ or WRITE delay	tRCD	14.16	–	14.25	–	14.32	–	13.75	–	ns	
PRECHARGE command period	tRP	14.16	–	14.25	–	14.32	–	13.75	–	ns	
ACTIVATE-to-PRECHARGE command period	tRAS	32	9 × tREFI	32	9 × tREFI	32	9 × tREFI	32	9 × tREFI	ns	13
ACTIVATE-to-ACTIVATE or REF command period	tRC	46.16	–	46.25	–	46.32	–	45.75	–	ns	13
ACTIVATE-to-ACTIVATE command period to different bank groups for 1/2KB page size	tRRD_S (1/2KB)	MIN = greater of 4CK or 3.3ns		MIN = greater of 4CK or 3.0ns		MIN = greater of 4CK or 2.7ns		MIN = greater of 4CK or 2.5ns		CK	1
ACTIVATE-to-ACTIVATE command period to different bank groups for 1KB page size	tRRD_S (1KB)	MIN = greater of 4CK or 3.3ns		MIN = greater of 4CK or 3.0ns		MIN = greater of 4CK or 2.7ns		MIN = greater of 4CK or 2.5ns		CK	1
ACTIVATE-to-ACTIVATE command period to different bank groups for 2KB page size	tRRD_S (2KB)	MIN = greater of 4CK or 5.3ns		MIN = greater of 4CK or 5.3ns		MIN = greater of 4CK or 5.3ns		MIN = greater of 4CK or 5.3ns		CK	1
ACTIVATE-to-ACTIVATE command period to same bank groups for 1/2KB page size	tRRD_L (1/2KB)	MIN = greater of 4CK or 4.9ns		MIN = greater of 4CK or 4.9ns		MIN = greater of 4CK or 4.9ns		MIN = greater of 4CK or 4.9ns		CK	1

Parameter	Symbol	DDR4-2400		DDR4-2666		DDR4-2933		DDR4-3200		Unit	Notes
		Min	Max	Min	Max	Min	Max	Min	Max		
Command and Address Timing											
ACTIVATE-to-ACTIVATE command period to same bank groups for 1KB page size	tRRD_L (1KB)	MIN = greater of 4CK or 4.9ns	MIN = greater of 4CK or 4.9ns	MIN = greater of 4CK or 4.9ns	MIN = greater of 4CK or 4.9ns	MIN = greater of 4CK or 4.9ns	MIN = greater of 4CK or 4.9ns	CK	1		
ACTIVATE-to-ACTIVATE command period to same bank groups for 2KB page size	tRRD_L (2KB)	MIN = greater of 4CK or 6.4ns	MIN = greater of 4CK or 6.4ns	MIN = greater of 4CK or 6.4ns	MIN = greater of 4CK or 6.4ns	MIN = greater of 4CK or 6.4ns	MIN = greater of 4CK or 6.4ns	CK	1		
Four ACTIVATE windows for 1/2KB page size	tFAW (1/2KB)	MIN = greater of 16CK or 13ns	MIN = greater of 16CK or 12ns	MIN = greater of 16CK or 10.875ns	MIN = greater of 16CK or 10ns			ns			
Four ACTIVATE windows for 1KB page size	tFAW (1KB)	MIN = greater of 20CK or 21ns	MIN = greater of 20CK or 21ns	MIN = greater of 20CK or 21ns	MIN = greater of 20CK or 21ns			ns			
Four ACTIVATE windows for 2KB page size	tFAW (2KB)	MIN = greater of 28CK or 30ns	MIN = greater of 28CK or 30ns	MIN = greater of 28CK or 30ns	MIN = greater of 28CK or 30ns			ns			
Command and Address Timing											
WRITE recovery time	tWR	MIN = 15ns						ns	5, 10, 1		
	tWR2	MIN = 1CK + tWR						CK	5, 11, 1		
WRITE recovery time when CRC and DM are both enabled	tWR_CRC_DM	MIN = tWR + greater of (5CK or 3.75ns)						CK	6, 10, 1		
	tWR_CRC_DM2	MIN = 1CK + tWR_CRC_DM						CK	6, 11, 1		
Delay from start of internal WRITE transaction to internal READ command – Same bank group	tWTR_L	MIN = greater of 4CK or 7.5ns						CK	5, 10, 1		
	tWTR_L2	MIN = 1CK + tWTR_L						CK	5, 11, 1		
Delay from start of internal WRITE transaction to internal READ command – Same bank group when CRC and DM are both enabled	tWTR_L_CRC_DM	MIN = tWTR_L + greater of (5CK or 3.75ns)						CK	6, 10, 1		
	tWTR_L_CRC_DM2	MIN = 1CK + tWTR_L_CRC_DM						CK	6, 11, 1		

Parameter	Symbol	DDR4-2400		DDR4-2666		DDR4-2933		DDR4-3200		Unit	Notes
		Min	Max	Min	Max	Min	Max	Min	Max		
Command and Address Timing											
Delay from start of internal WRITE transaction to internal READ command – Different bank group	tWTR_S	MIN = greater of (2CK or 2.5ns)								CK	5, 7, 8, 10, 1
	tWTR_S2	MIN = 1CK + tWTR_S								CK	5, 7, 8, 11, 1
Delay from start of internal WRITE transaction to internal READ command – Different bank group when CRC and DM are both enabled	tWTR_S_CRC_D M	MIN = tWTR_S + greater of (5CK or 3.75ns)								CK	6, 7, 8, 10, 1
	tWTR_S_CRC_D M2	MIN = 1CK + tWTR_S_CRC_DM								CK	6, 7, 8, 11, 1
READ-to-PRECHARGE time	tRTP	MIN = greater of 4CK or 7.5ns								CK	1
CAS_n-to-CAS_n command delay to different bank group	tCCD_S	4	–	4	–	4	–	4	–	CK	
CAS_n-to-CAS_n command delay to samebank group	tCCD_L	MIN = greater of 5CK or 5ns	–	MIN = greater of 5CK or 5ns	–	MIN = greater of 5CK or 5ns	–	MIN = greater of 5CK or 5ns	–	CK	15
Auto precharge write recovery + precharge time	tDAL (MIN)	MIN = WR + ROUNDUPtRP/tCK (AVG); MAX = N/A								CK	
MRS Command Timing											
MRS command cycle time	tMRD	8	–	8	–	8	–	8	–	CK	
MRS command cycle time in PDA mode	tMRD_PDA	MIN = greater of (16nCK, 10ns)									1
MRS command cycle time in CAL mode	tMRD_CAL	MIN = tMOD + tCAL								CK	
MRS command update delay	tMOD	MIN = greater of (24nCK, 15ns)								CK	1
MRS command update delay in PDA mode	tMOD_PDA	MIN = tMOD								CK	
MRS command update delay in CAL mode	tMOD_CAL	MIN = tMOD + tCAL CK								CK	

Parameter	Symbol	DDR4-2400		DDR4-2666		DDR4-2933		DDR4-3200		Unit	Notes	
		Min	Max	Min	Max	Min	Max	Min	Max			
MRS Command Timing												
MRS command to DQS drive in preamble training	tSDO	MIN = tMOD + 9ns									CK	
MPR Command Timing												
Multipurpose register recovery time	tMPRR	MIN = 1CK									CK	
Multipurpose register write recovery time	tWR_MPRR	MIN = tMOD + AL + PL										
CRC Error Reporting Timing												
CRC error to ALERT_n latency	tCRC_ALERT	3	13	3	13	3	13	3	13	ns		
CRC ALERT_n pulse width	tCRC_ALERT_PW	6	10	6	10	6	10	6	10	CK		
CA Parity Timing												
Parity latency	PL	5	-	5	-	6	-	6	-	CK		
Commands uncertain to be executed during this time	tPAR_UNKNOWN	-	PL	-	PL	-	PL	-	PL	CK		
Delay from errant command to ALERT_n assertion	tPAR_ALERT_ON	-	PL + 6ns	-	PL + 6ns	-	PL + 6ns	-	PL + 6ns	CK		
Pulse width of ALERT_n signal when asserted	tPAR_ALERT_PW	72	144	80	160	88	176	96	192	CK		
Time from alert asserted until DES command srequired in persistent CA paritymode	tPAR_ALERT_RSP	-	64	-	71	-	78	-	85	CK		
CAL Timing												
CS_n to command address latency	tCAL	5	-	5	-	6	-	6	-	CK	20	
CS_n to command address latency in gear-down mode	tCALg	N/A	-	6	-	8	-	8	-	CK		
MPSM Timing												
Command path disable delay upopn MPSM entry	tMPED	MIN = tMOD (MIN) + tCPDED (MIN)									CK	1
Valid clock requirement after MPSM entry	tCKMPE	MIN = tMOD (MIN) + tCPDED (MIN)									CK	1
Valid clock requirement before MPSM	tCKMPX	MIN = tCKSRX (MIN)									CK	1

Parameter	Symbol	DDR4-2400		DDR4-2666		DDR4-2933		DDR4-3200		Unit	Notes	
		Min	Max	Min	Max	Min	Max	Min	Max			
MPSM Timing												
Exit MPSM to commands not requiring a locked DLL	tXMP	tXS (MIN)								CK		
Exit MPSM to commands requiring a locked DLL	tXMPDLL	MIN = tXMP (MIN) + tXSDLL (MIN)								CK	1	
CS setup time to CKE	tMPX_S	MIN = tIS (MIN) + tIH (MIN)								ns		
CS_n HIGH hold time to CKE rising edge	tMPX_HH	MIN = tXP								ns		
CS_n LOW hold time to CKE rising edge	tMPX_LH	12	tXMP -10ns	12	tXMP -10ns	12	tXMP -10ns	12	tXMP -10ns	ns		
Connectivity Test Timing												
TEN pin HIGH to CS_n LOW – Enter CT mode	tCT_Enable	200	–	200	–	200	–	200	–	ns		
CS_n LOW and valid input to valid output	tCT_Valid	–	200	–	200	–	200	–	200	ns		
CK_t, CK_c valid and CKE HIGH after TEN goes HIGH	tCTCKE_Valid	10	–	10	–	10	–	10	–	ns		
Calibration and VREFDQ Train Timing												
ZQCL command: Long calibration time	POWER-UP and RESET operation	tZQinit	1024	–	1024	–	1024	–	1024	–	CK	
	Normal operation	tZQoper	512	–	512	–	512	–	512	–	CK	
ZQCS command: Short calibration time		tZQCS	128	–	128	–	128	–	128	–	CK	
The VREF increment/decrement step time		VREF_time	MIN = 150ns									
Enter VREFDQ training mode to the first write or VREFDQ MRS command delay		tVREFDQE	MIN = 150ns								ns	1
Exit VREFDQ training mode to the first WRITE command delay		tVREFDQX	MIN = 150ns								ns	1

Parameter	Symbol	DDR4-2400		DDR4-2666		DDR4-2933		DDR4-3200		Unit	Notes	
		Min	Max	Min	Max	Min	Max	Min	Max			
Initialization and Reset Timing												
Exit reset from CKE HIGH to a valid command	tXPR	MIN = greater of 5CK or tRFC (MIN) + 10ns								CK	1	
RESET_L pulse low after power stable	tPW_REST_S	1.0	-	1.0	-	1.0	-	1.0	-	µs		
RESET_L pulse low at power-up	PW_REST_L	200	-	200	-	200	-	200	-	µs		
Begin power supply ramp to power supplies stable	tVDDPR	MIN = N/A; MAX = 200								ms		
RESET_n LOW to power supplies stable	tRPS	MIN = 0; MAX = 0								ns		
RESET_n LOW to I/O and RTT High-Z	tIOZ	MIN = N/A; MAX = undefined								ns		
Refresh Timing												
REFRESH-to-ACTIVATE or REFRESH command period (all bank groups)	4Gb	tRFC1	MIN = 260								ns	1, 12
		tRFC2	MIN = 160								ns	1, 12
		tRFC4	MIN = 110								ns	1, 12
	8Gb	tRFC1	MIN = 350								ns	1, 12
		tRFC2	MIN = 260								ns	1, 12
		tRFC4	MIN = 160								ns	1, 12
	16Gb	tRFC1	MIN = 550								ns	1, 12
		tRFC2	MIN = 350								ns	1, 12
		tRFC4	MIN = 260								ns	1, 12
Average periodic refresh interval	0°C ≤ TC ≤ 85°C	tREFI	MIN = N/A; MAX = 7.8								ns	12
	85°C < TC ≤ 95°C	tREFI	MIN = N/A; MAX = 3.9								µs	12
Self Refresh Timing												
Exit self refresh to commands not requiring a locked DLL SRX to commands not requiring a locked DLL in self refresh abort	tXS	MIN = tRFC + 10ns								ns	1	
Exit self refresh to ZQCL, ZQCS and MRS (CL, CWL, WR, RTP and gear-down)	tXS_ABORT	MIN = tRFC4 + 10ns								ns	1	
	tXS_FAST	MIN = tRFC4 + 10ns								ns	1	

Parameter	Symbol	DDR4-2400		DDR4-2666		DDR4-2933		DDR4-3200		Unit	Notes
		Min	Max	Min	Max	Min	Max	Min	Max		

Self Refresh Timing											
Exit self refresh to commands requiring a locked DLL	tXSDLL	MIN = tDLLK (MIN)								CK	1
Minimum CKE low pulse width for self refresh entry to self refresh exit timing	tCKESR	MIN = tCKE (MIN) + 1nCK								CK	1
Minimum CKE low pulse width for self refresh entry to self refresh exit timing when CA parity is enabled	tCKESR_PAR	MIN = tCKE (MIN) + 1nCK + PL								CK	1
Valid clocks after self refresh entry (SRE) or power-down entry (PDE)	tCKSRE	MIN = greater of (5CK, 10ns)								CK	1
Valid clock requirement after self refresh entry or power-down when CA parity is enabled	tCKSRE_PAR	MIN = greater of (5CK, 10ns) + PL								CK	1
Valid clocks before self refresh exit (SRX) or power-down exit (PDX), or reset exit	tCKSRX	MIN = greater of (5CK, 10ns)								CK	1
Power-Down Timing											
Exit power-down with DLL on to any valid command	tXP	MIN = greater of 4CK or 6ns								CK	1
Exit precharge power-down with DLL frozen to commands not requiring a locked DLL when CA Parity is enabled	tXP_PAR	MIN = (greater of 4CK or 6ns) + PL								CK	1
CKE MIN pulse width	tCKE (MIN)	MIN = greater of 3CK or 5ns								CK	
Command pass disable delay	tCPDED	4	-	4	-	4	-	4	-	CK	
Power-down entry to power-down exit timing	tPD	MIN = tCKE (MIN); MAX = 9 × tREFI								CK	
Begin power-down period prior to CKE registered HIGH	tANPD	WL - 1CK								CK	
Power-down entry period: ODT either synchronous or asynchronous	PDE	Greater of tANPD or tRFC - REFRESH command to CKE LOW time								CK	

Parameter	Symbol	DDR4-2400		DDR4-2666		DDR4-2933		DDR4-3200		Unit	Notes
		Min	Max	Min	Max	Min	Max	Min	Max		

Power-Down Timing											
Power-down exit period: ODT either synchronous or asynchronous	PDX	tANPD + tXSDLL								CK	
Power-Down Entry Minimum Timing											
ACTIVATE command to power-down entry	tACTPDEN	2	-	2	-	2	-	2	-	CK	
PRECHARGE/PRECHARGE ALL command to power-down entry	tPRPDEN	2	-	2	-	2	-	2	-	CK	
REFRESH command to power-down entry	tREFPDEN	2	-	2	-	2	-	2	-	CK	
MRS command to power-down entry	tMRSPDEN	MIN = tMOD (MIN)								CK	1
READ/READ with auto precharge command to power-down entry	tRDPDEN	MIN = RL + 4 + 1								CK	1
WRITE command to power-down entry (BL8OTF, BL8MRS, BC4OTF)	tWRPDEN	MIN = WL + 4 + tWR/tCK (AVG)								CK	1
WRITE command to power-down entry(BC4MRS)	tWRPBC4DEN	MIN = WL + 2 + tWR/tCK (AVG)								CK	1
WRITE with auto precharge command to power-down entry (BL8OTF,BL8MRS,BC4OTF)	tWRAPDEN	MIN = WL + 4 + WR + 1								CK	1
WRITE with auto precharge command to power-down entry (BC4MRS)	tWRAPBC4DEN	MIN = WL + 2 + WR + 1								CK	1
ODT Timing											
Direct ODT turn-on latency	DODTLon	WL - 2 = CWL + AL + PL - 2								CK	
Direct ODT turn-off latency	DODTLoff	WL - 2 = CWL + AL + PL - 2								CK	
R _{TT} dynamic change skew	tADC	0.3	0.7	0.28	0.72	0.26	0.74	0.26	0.74	CK	
Asynchronous RTT(NOM) turn-on delay (DLL off)	tAONAS	1	9	1	9	1	9	1	9	ns	
Asynchronous RTT(NOM) turn-off delay (DLL off)	tAOFAS	1	9	1	9	1	9	1	9	ns	

Parameter	Symbol	DDR4-2400		DDR4-2666		DDR4-2933		DDR4-3200		Unit	Notes
		Min	Max	Min	Max	Min	Max	Min	Max		

ODT Timing											
ODT HIGH time with WRITE command and BL8	ODTH8 1'CK	6	–	6	–	6	–	6	–	CK	
	ODTH8 2'CK	7	–	7	–	7	–	7	–		
ODT HIGH time without WRITE command or with WRITE command and BC4	ODTH4 1'CK	4	–	4	–	4	–	4	–	CK	
	ODTH4 2'CK	5	–	5	–	5	–	5	–		
Write Leveling Timing											
First DQS_t, DQS_c rising edge after write leveling mode is programmed	tWLMRD	40	–	40	–	40	–	40	–	CK	
DQS_t, DQS_c delay after write leveling mode is programmed	tWLDQSEN	25	–	25	–	25	–	25	–	CK	
Write leveling setup from rising CK_t, CK_c crossing to rising DQS_t, DQS_c crossing	tWLS	0.13	–	0.13	–	0.13	–	0.13	–	tCK (AVG)	
Write leveling hold from rising DQS_t, DQS_c crossing to rising CK_t, CK_c crossing	tWLH	0.13	–	0.13	–	0.13	–	0.13	–	tCK (AVG)	
Write leveling output delay	tWLO	0	9.5	0	9.5	0	9.5	0	9.5	ns	
Write leveling output error	tWLOE	0	2	0	2	0	2	0	2	ns	
Gear-Down Timing (Not Supported Below DDR4-2666)											
Exit reset from CKE HIGH to a valid MRS gear-down	tXPR_GEAR	N/A		tXPR		tXPR		tXPR		CK	
CKE HIGH assert to gear-down enable time	tXS_GEAR	N/A		tXS		tXS		tXS		CK	
MRS command to sync pulse time	tSYNC_GEAR	N/A		tMOD + 4CK		tMOD + 4CK		tMOD + 4CK		CK	
Sync pulse to first valid command	tCMD_GEAR	N/A		tMOD		tMOD		tMOD		CK	
Gear-down setup time	tGEAR_setup	N/A	–	2CK	–	2CK	–	2CK	–	CK	
Gear-down hold time	tGEAR_hold	N/A	–	2CK	–	2CK	–	2CK	–	CK	

NOTES :

1. Maximum limit not applicable.

-
2. tCCD_L and tDLLK should be programmed according to the value defined per operating frequency.
 3. Data rate is greater than or equal to 1066 Mb/s.
 4. RFU.
 5. WRITE-to-READ when CRC and DM are both not enabled.
 6. WRITE-to-READ delay when CRC and DM are both enabled.
 7. The start of internal write transactions is defined as follows:
 - For BL8 (fixed by MRS and on-the-fly): rising clock edge four clock cycles after WL
 - For BC4 (on-the-fly): rising clock edge four clock cycles after WL
 - For BC4 (fixed by MRS): rising clock edge two clock cycles after WL
 8. For these parameters, the device supports $t_{nPARAM} [nCK] = RU\{t_{PARAM} [ns]/t_{CK} (AVG) [ns]\}$, in clock cycles, assuming all input clock jitter specifications are satisfied.
 9. Although unlimited row accesses to the same row is allowed within the refresh period, excessive row accesses to the same row over a long term can result in degraded operation.
 10. When operating in 1tCK WRITE preamble mode.
 11. When operating in 2tCK WRITE preamble mode.
 12. When CA parity mode is selected and the DLLoff mode is used, each REF command requires an additional "PL" added to tRFC refresh time.
 13. DRAM devices should be evenly addressed when being accessed. Disproportionate accesses to a particular row address may result in reduction of the product lifetime and/or reduction in data retention ability.
 14. Applicable from tCK (AVG) MIN to tCK (AVG) MAX as stated in the Speed Bin tables.
 15. JEDEC specifies a minimum of five clocks.
 16. The maximum read postamble is bound by tDQSCK (MIN) plus tQSH (MIN) on the left side and tHZ(DQS) MAX on the right side.
 17. The reference level of DQ output signal is specified with a midpoint as a widest part of output signal eye, which should be approximately $0.7 \times VDDQ$ as a center level of the static single-ended output peak-to-peak swing with a driver impedance of 34 ohms and an effective test load of 50 ohms to $V_{TT} = VDDQ$.
 18. JEDEC hasn't agreed upon the definition of the deterministic jitter; the user should focus on meeting the total limit.
 19. Spread spectrum is not included in the jitter specification values. However, the input clock can accommodate spread-spectrum at a sweep rate in the range of 20–60 kHz with an additional 1% of tCK (AVG) as a long-term jitter component; however, the spread spectrum may not use a clock rate below tCK (AVG) MIN.
 20. The actual tCAL minimum is the larger of 3 clocks or 3.748ns/tCK; the table lists the applicable clocks required at targeted speed bin.
 21. The maximum READ preamble is bounded by tLZ(DQS) MIN on the left side and tDQSCK (MAX) on the right side. See figure in Clock to Data Strobe Relationship. Boundary of DQS Low-Z occur one cycle earlier in 2tCK toggle mode which is illustrated in READ Preamble.
 22. DQ falling signal middle-point of transferring from HIGH to LOW to first rising edge of DQS differential signal cross-point.
 23. The tPDA_S/tPDA_H parameters may use the tDS/tDH limits, respectively, if the signal is LOW the entire BL8
-

SERIAL PRESENCE DETECT SPECIFICATION (AQD-D4U16GN32-SE Serial Presence Detect)

Byte	Function Described	Function	HEX Value
0	Number of Bytes Used / Number of Bytes in SPD Device / CRC Coverage	SPD Total: 512Bytes, SPD Used : 384Bytes	23
1	SPD Revision	Version 1.1	11
2	Key Byte / DRAM Device Type	DDR4 SDRAM	0C
3	Key Byte / Module Type	U-DIMM	02
4	SDRAM Density and Banks	4 bank group / 4 bank 8Gb	85
5	SDRAM Addressing	Row : 16 Column : 10	21
6	SDRAM Package Type	Mono / Not specified	00
7	SDRAM Optional Features	Unlimited MAC	08
8	SDRAM Thermal and Refresh Options	-	00
9	Other SDRAM Optional Features	hPPR,sPPR supported	60
10	Reserved	-	00
11	Module Nominal Voltage, VDD	1.2v	03
12	Module Organization	2Rank x8	09
13	Module Memory Bus Width	Non ECC 64bits	03
14	Module Thermal Sensor	Non Thermal Sensor	00
15-16	Reserved	-	00
17	Timebases	MTB: 125ps FTB: 1ps	00
18	SDRAM Minimum Cycle Time (tCKAVGmin)	0.625 ns	05
19	SDRAM Maximum Cycle Time (tCKAVGmax)	1.6 ns	0D
20	CAS Latencies Supported, First Byte	CL 10,11,12,13,14	F8
21	CAS Latencies Supported, Second Byte	CL 15,16,17,18,19,20,22	BF
22	CAS Latencies Supported, Third Byte	CL24	02
23	CAS Latencies Supported, Fourth Byte	-	00
24	Minimum CAS Latency Time(tAAMin)	13.75 ns	6E
25	Minimum RAS to CAS Delay Time (tRCDmin)	13.75 ns	6E
26	Minimum Row Precharge Delay Time (tRPmin)	13.75 ns	6E
27	Upper Nibbles for tRASmin and tRCmin	-	11
28	Minimum Active to Precharge Delay Time (tRASmin), Least Significant Byte	32 ns	00
29	Minimum Active to Active/Refresh Delay Time (tRCmin), Least Significant Byte	45.75 ns	6E
30	Minimum Refresh Recovery Delay Time (tRFC1min), Least Significant Byte	-	F0
31	Minimum Refresh Recovery Delay Time (tRFC1min), Most Significant Byte	350 ns	0A
32	Minimum Refresh Recovery Delay Time (tRFC2min), Least Significant Byte	-	20
33	Minimum Refresh Recovery Delay Time (tRFC2min), Most Significant Byte	260 ns	08
34	Minimum Refresh Recovery Delay Time (tRFC4min), Least Significant Byte	-	00
35	Minimum Refresh Recovery Delay Time (tRFC4min), Most Significant Byte	160 ns	05
36	Minimum Four Activate Window Time (tFAWmin), Most Significant Nibble	21 ns	00
37	Minimum Four Activate Window Time (tFAWmin), Least Significant Byte	-	A8
38	Minimum Activate to Activate Delay Time (tRRD_Smin), different bank group	2.5 ns	14
39	Minimum Activate to Activate Delay Time (tRRD_Lmin), same bank group	4.9 ns	28
40	Minimum CAS to CAS Delay Time (tCCD_Lmin), same bank group	5 ns	28
41	Upper Nibble for tWRmin	15 ns	00
42	Minimum Write Recovery Time(tWRmin)	15 ns	78
43	Upper Nibbles for tWTRmin	2.5/7.5 ns	00
44	Minimum Write to Read Time(tWTR_Smin) , different bank group	2.5 ns	14
45	Minimum Write to Read Time(tWTR_Lmin) , same bank group	7.5 ns	3C
46-59	Reserved, Base Configuration Section	-	00
60	Connector to SDRAM Bit Mapping	DQ0, DQ1, DQ2, DQ3	15
61	Connector to SDRAM Bit Mapping	DQ4, DQ5, DQ6, DQ7	2B
62	Connector to SDRAM Bit Mapping	DQ8, DQ9, DQ10, DQ11	16
63	Connector to SDRAM Bit Mapping	DQ12, DQ13, DQ14, DQ15	36
64	Connector to SDRAM Bit Mapping	DQ16, DQ17, DQ18, DQ19	0B
65	Connector to SDRAM Bit Mapping	DQ20, DQ21, DQ22, DQ23	2B
66	Connector to SDRAM Bit Mapping	DQ24, DQ25, DQ26, DQ27	0C
67	Connector to SDRAM Bit Mapping	DQ28, DQ29, DQ30, DQ31	36
68	Connector to SDRAM Bit Mapping	CB0-3	00
69	Connector to SDRAM Bit Mapping	CB4-7	00
70	Connector to SDRAM Bit Mapping	DQ32, DQ33, DQ34, DQ35	36
71	Connector to SDRAM Bit Mapping	DQ36, DQ37, DQ38, DQ39	15
72	Connector to SDRAM Bit Mapping	DQ40, DQ41, DQ42, DQ43	2B
73	Connector to SDRAM Bit Mapping	DQ44, DQ45, DQ46, DQ47	0C
74	Connector to SDRAM Bit Mapping	DQ48, DQ49, DQ50, DQ51	2C
75	Connector to SDRAM Bit Mapping	DQ52, DQ53, DQ54, DQ55	16
76	Connector to SDRAM Bit Mapping	DQ56, DQ57, DQ58, DQ59	2B

Byte	Function Described	Function	HEX Value
77	Connector to SDRAM Bit Mapping	DQ60, DQ61, DQ62, DQ63	0C
78~116	Reserved, Base Configuration Section	-	00
117	Fine Offset for Minimum CAS to CAS Delay Time(tCCD_Lmin), same bank group	0ns	00
118	Fine Offset for Minimum Activate to Activate Delay Time(tRRD_Lmin), different bank group	-0.1ns	9C
119	Fine Offset for Minimum Activate to Activate Delay Time(tRRD_Smin), same bank group	0ns	00
120	Fine Offset for Minimum Activate to Activate/Refresh Delay Time(tRCmin)	0ns	00
121	Fine Offset for Minimum Row Precharge Delay Time(tRPmin)	0ns	00
122	Fine Offset for Minimum RAS to CAS Delay Time(tRCDmin)	0ns	00
123	Fine Offset for Minimum CAS Latency Time(tAmin)	0ns	00
124	Fine Offset for SDRAM Maximum Cycle Time(tCKAVGmax)	-0.025ns	E7
125	Fine Offset for SDRAM Minimum Cycle Time(tCKAVGmin)	0ns	00
126	Cyclical Redundancy Code for Base Configuration Section, LSB	CRC-CCITT(LOW)	88
127	Cyclical Redundancy Code for Base Configuration Section, MSB	CRC-CCITT(HIGH)	C7
128	(Unbuffered): Raw Card Extension, Module Nominal Height	Revision 2 31.25 mm	11
129	(Unbuffered): Module Maximum Thickness	-	11
130	(Unbuffered): Reference Raw Card Used	Raw Card B Revision 2	41
131	(Unbuffered): Address Mapping from Edge Connector to DRAM	Mirrored	01
132~253	(Unbuffered): Reserved	-	00
254	(Unbuffered): CRC for Module Specific Section, Least Significant Byte	CRC-CCITT(LOW)	AB
255	(Unbuffered): CRC for Module Specific Section, Most Significant Byte	CRC-CCITT(HIGH)	C6
256~319	Hybrid Memory Architecture Specific Parameters		00
320	Module Manufacturer ID Code, LSB		04
321	Module Manufacturer ID Code, MSB		CB
322	Module ID: Module Manufacturing Location	*Note: 1	-
323	Module ID: Module Manufacturing Date(YEAR)	*Note: 2	-
324	Module ID: Module Manufacturing Date(WEEK)	*Note: 3	-
325~328	Module ID: Module Serial Number	*Note: 4	-
329~348	Module Part Number	*Note: 5	-
349	Module Revision Code	-	00
350	SDRAM Manufacturer's JEDEC ID Code, LSB	Samsung	80
351	SDRAM Manufacturer's JEDEC ID Code, MSB		CE
352	DRAM Stepping	-	FF
353~381	Manufacturer's Specific Data	*Note: 7	-
382	Reserved		00
383	Reserved		00
384~511	End User Programmable	*Note: 8	-

- Note :
1. Byte 322 -- Manufacturing location by manufacturing location (00:Taiwan /01:China)
 2. Byte 323 -- Module manufacturing date by year (YY).
 3. Byte 324 -- Module manufacturing date by week (WW).
 4. Bytes 325~328 -- Module Serial Number.
 5. Bytes 329~348 -- Manufacturer Part Number by module part number , (Unused digits are coded as ASCII blanks (20h)).
 6. Bytes 353~381 -- These bytes are undefined and can be used own purpose. Digits are coded as 00h except the following:
 - 6-1. Bytes 353~367 -- Manufacturer's Specific Data by working order number.
 - 6-2. Bytes 368~381 -- Manufacturer's Specific Data by SPD naming number.
 7. Bytes 384~511 -- These bytes are undefined and can be used own purpose. Digits are coded as 00h except the following:
 - 7-1. Bytes 384 -- The byte is coded as ADh.

Tento produkt můžete zakoupit u společnosti AutoCont IPC a.s.



AutoCont IPC a.s.

Váš dodavatel průmyslových počítačů, komponent a speciálních průmyslových IT systémů.

 Uhlířská 1064/3, 710 00 Ostrava, Česká republika

 obchod@autocont-ipc.cz

 +420 552 301 002

 www.autocont-ipc.cz



PRŮMYSLOVÉ POČÍTAČE

fanless embedded PC, do racku, ...



POČÍTAČE S DISPLEJEM

panelové PC, terminály, do vozidel, ...



AUTOMATIZACE A SBĚR DAT

převodníky, karty, moduly, switche, ...



PERIFERIE A KOMPONENTY

monitory, klávesnice, desky, skříně, ...



NOTEBOOKY A TABLETY

odolné, windows, android, IP65, ...



INFORMAČNÍ KIOSKY

interiérové, venkovní, ...



MEDICÍNSKÁ TECHNIKA

počítače, tablety, LCD, klávesnice, ...



SOFTWAREVÁ ŘEŠENÍ

pro výrobu, zaměstnance, kiosky, ...



PŘEJÍT DO E-SHOPU

eshop.autocont-ipc.cz



DOPRAVA ZDARMA

Doprava zdarma v ČR a SR při objednávce nad 10 000 Kč bez DPH nebo nad 400 EUR.



PRODLOUŽENÁ ZÁRUKA

Záruka 2 roky na vyráběné počítače s možností jejího prodloužení až na 5 let.



ODMĚNA ZA VĚRNOST

Pravidelní zákazníci u nás nakupují za nižší ceny. Výše slevy se odvíjí od realizovaného obrátu.



SERVIS ON-SITE A IN-TIME

K projektovým dodávkám nabízíme rozšířenou podporu a servis s garancí výměny zařízení do 48 hodin.