

Advantech

AQD-D3L8GN16-SG1 Datasheet

Rev. 0.0

2017-07-07

Description

AQD-D3L8GN16-SG1 is a DDR3L 1600Mbps U-DIMM high-speed, memory module that use 16pcs of 512Mx 64 bits DDR3L SDRAM in FBGA package and a 2K bits serial EEPROM on a 240-pin printed circuit board. AQD-D3L8GN16-SG1 is a Dual In-Line Memory Module and is intended for mounting into 240-pin edge connector sockets.

Synchronous design allows precise cycle control with the use of system clock. Data I/O transactions are possible on both edges of DQS. Range of operation frequencies, programmable latencies allow the same device to be useful for a variety of high bandwidth, high performance memory system applications.

Features

- Lead-free and Halogen free products are RoHS Compliant
- JEDEC standard 1.35V(1.28V~1.45V) Power supply
- Backward compatible for 1.5V(1.425V~1.575V)
- VDDQ=1.35V(1.28V~1.45V) & 1.5V(1.425V~1.575V)
- MRS Cycle with address key programs
 - CAS Latency(5,6,7,8,9,10,11)
 - Burst Length (BL):8 and 4 with Burst Chop(BC)
- Bi-directional, differential data strobe (DQS and /DQS)
- Differential clock input (CK, /CK) operation
- 8 bit pre-fetch
- Double-data-rate architecture; two data transfers per clock cycle
- Internal calibration through ZQ pin
- On Die Termination with ODT pin
- Auto refresh and self refresh
Average Refresh Period 7.8us at lower than TCASE
85°C, 3.9us at 85°C < TCASE ≤ 95°C
- PCB Gold Plating: 30u" min

Pin Identification

Symbol	Function
A0~A14, BA0~BA2	Address/Bank input
DQ0~DQ63	Bi-direction data bus.
DQS0~DQS7	Data strobes
/DQS0~/DQS7	Differential Data strobes
CK0, /CK0,CK1, /CK1	Clock Input. (Differential pair)
CKE0, CKE1	Clock Enable Input.
ODT0, ODT1	On-die termination control line
/S0, /S1	DIMM rank select lines.
/RAS	Row address strobe
/CAS	Column address strobe
/WE	Write Enable
DM0~DM7	Data masks/high data strobes
VDD	Core power supply
VDDQ	I/O driver power supply
V _{REF} DQ	DQ reference supply
V _{REF} CA	Command/address reference supply
V _{DD} SPD	SPD EEPROM power supply
SA0~SA2	I2C serial bus address select for EEPROM
SCL	I2C serial bus clock for EEPROM
SDA	I2C serial bus data for EEPROM
VSS	Ground
/RESET	Set DRAMs Known State
VTT	DRAM I/O termination supply
NC	No Connection

Dimensions (Unit: millimeter)

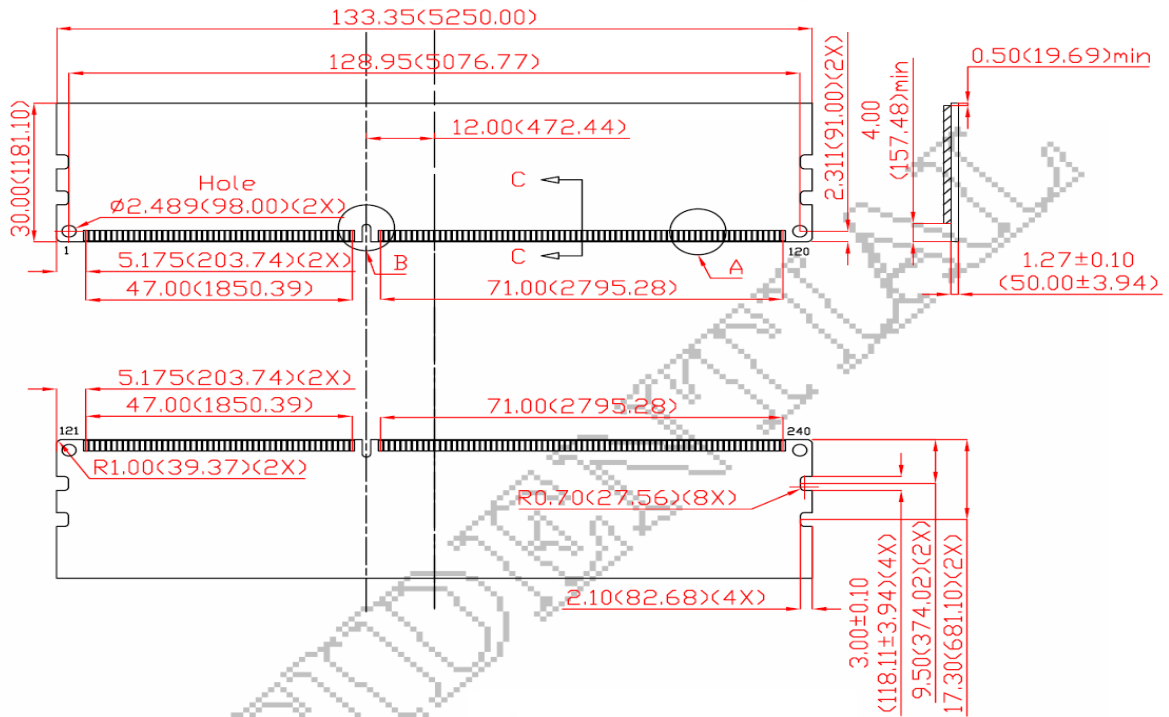
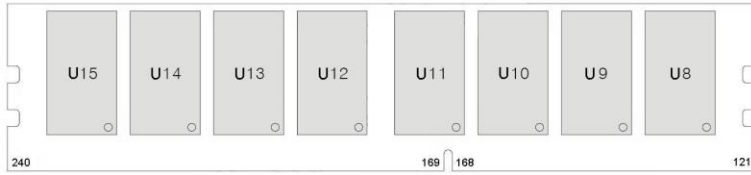
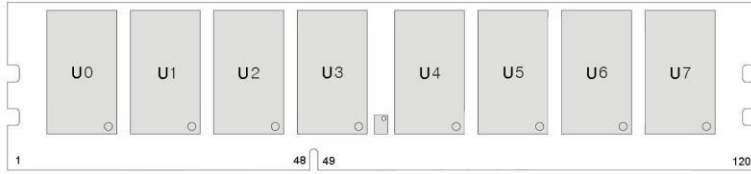

Note:
1. Tolerance : $\pm 0.15\text{mm}$ (5.91mils)

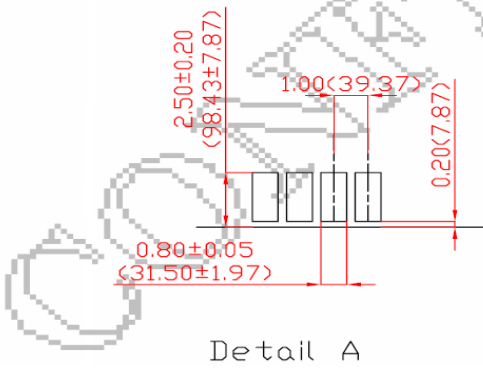

Detail A

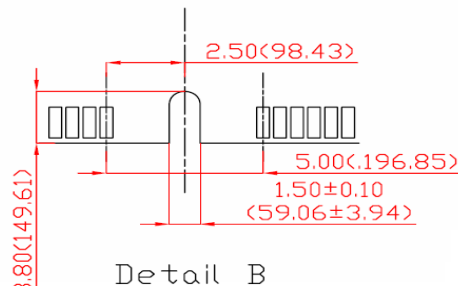

Detail B

Note: 1. Tolerances on all dimensions $\pm 0.15\text{mm}$ unless otherwise specified.

Pin Assignments

Pin No	Pin Name	Pin No	Pin Name	Pin No	Pin Name	Pin No	Pin Name	Pin No	Pin Name	Pin No	Pin Name
1	VREFDQ	41	VSS	81	DQ32	121	VSS	161	NC,DM8	201	DQ37
2	VSS	42	NC	82	DQ33	122	DQ4	162	NC	202	VSS
3	DQ0	43	NC	83	VSS	123	DQ5	163	VSS	203	DM4
4	DQ1	44	VSS	84	/DQS4	124	VSS	164	NC,CB6	204	NC
5	VSS	45	NC,CB2	85	DQS4	125	DM0	165	NC,CB7	205	VSS
6	/DQS0	46	NC,CB3	86	VSS	126	NC	166	VSS	206	DQ38
7	DQS0	47	VSS	87	DQ34	127	VSS	167	NC	207	DQ39
8	VSS	48	NC	88	DQ35	128	DQ6	168	/RESET	208	VSS
9	DQ2	49	NC	89	VSS	129	DQ7	169	CKE1,NC	209	DQ44
10	DQ3	50	CKE0	90	DQ40	130	VSS	170	VDD	210	DQ45
11	VSS	51	VDD	91	DQ41	131	DQ12	171	A15	211	VSS
12	DQ8	52	BA2	92	VSS	132	DQ13	172	A14	212	DM5
13	DQ9	53	NC	93	/DQS5	133	VSS	173	VDD	213	NC
14	VSS	54	VDD	94	DQS5	134	DM1	174	A12	214	VSS
15	/DQS1	55	A11	95	VSS	135	NC	175	A9	215	DQ46
16	DQS1	56	A7	96	DQ42	136	VSS	176	VDD	216	DQ47
17	VSS	57	VDD	97	DQ43	137	DQ14	177	A8	217	VSS
18	DQ10	58	A5	98	VSS	138	DQ15	178	A6	218	DQ52
19	DQ11	59	A4	99	DQ48	139	VSS	179	VDD	219	DQ53
20	VSS	60	VDD	100	DQ49	140	DQ20	180	A3	220	VSS
21	DQ16	61	A2	101	VSS	141	DQ21	181	A1	221	DM6
22	DQ17	62	VDD	102	/DQS6	142	VSS	182	VDD	222	NC
23	VSS	63	CK1,NC	103	DQS6	143	DM2	183	VDD	223	VSS
24	/DQS2	64	/CK1,NC	104	VSS	144	NC	184	CK0	224	DQ54
25	DQS2	65	VDD	105	DQ50	145	VSS	185	/CK0	225	DQ55
26	VSS	66	VDD	106	DQ51	146	DQ22	186	VDD	226	VSS
27	DQ18	67	VREFCA	107	VSS	147	DQ23	187	NC,/EVENT	227	DQ60
28	DQ19	68	NC	108	DQ56	148	VSS	188	A0	228	DQ61
29	VSS	69	VDD	109	DQ57	149	DQ28	189	VDD	229	VSS
30	DQ24	70	A10/AP	110	VSS	150	DQ29	190	BA1	230	DM7
31	DQ25	71	BA0	111	/DQS7	151	VSS	191	VDD	231	NC
32	VSS	72	VDD	112	DQS7	152	DM3	192	/RAS	232	VSS
33	/DQS3	73	/WE	113	VSS	153	NC	193	/S0	233	DQ62
34	DQS3	74	/CAS	114	DQ58	154	VSS	194	VDD	234	DQ63
35	VSS	75	VDD	115	DQ59	155	DQ30	195	ODT0	235	VSS
36	DQ26	76	/S1,NC	116	VSS	156	DQ31	196	A13	236	VDDSPD
37	DQ27	77	ODT1,NC	117	SA0	157	VSS	197	VDD	237	SA1
38	VSS	78	VDD	118	SCL	158	NC,CB4	198	NC	238	SDA
39	NC,CB0	79	NC	119	SA2	159	NC,CB5	199	VSS	239	VSS
40	NC,CB1	80	VSS	120	VTT	160	VSS	200	DQ36	240	VTT

/S1,ODT1,CKE1 : Used for dual-rank UDIMMs; NC on single-rank UDIMMs.

CK1 and /CK1 : Used for dual-rank UDIMMs; not used on single-rank UDIMMs but terminated.

8GB, 512Mx16 Module (2 Rank x8)

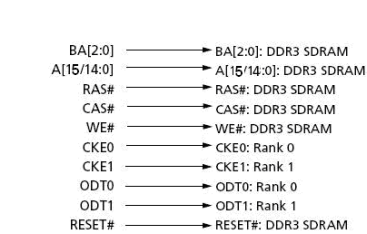
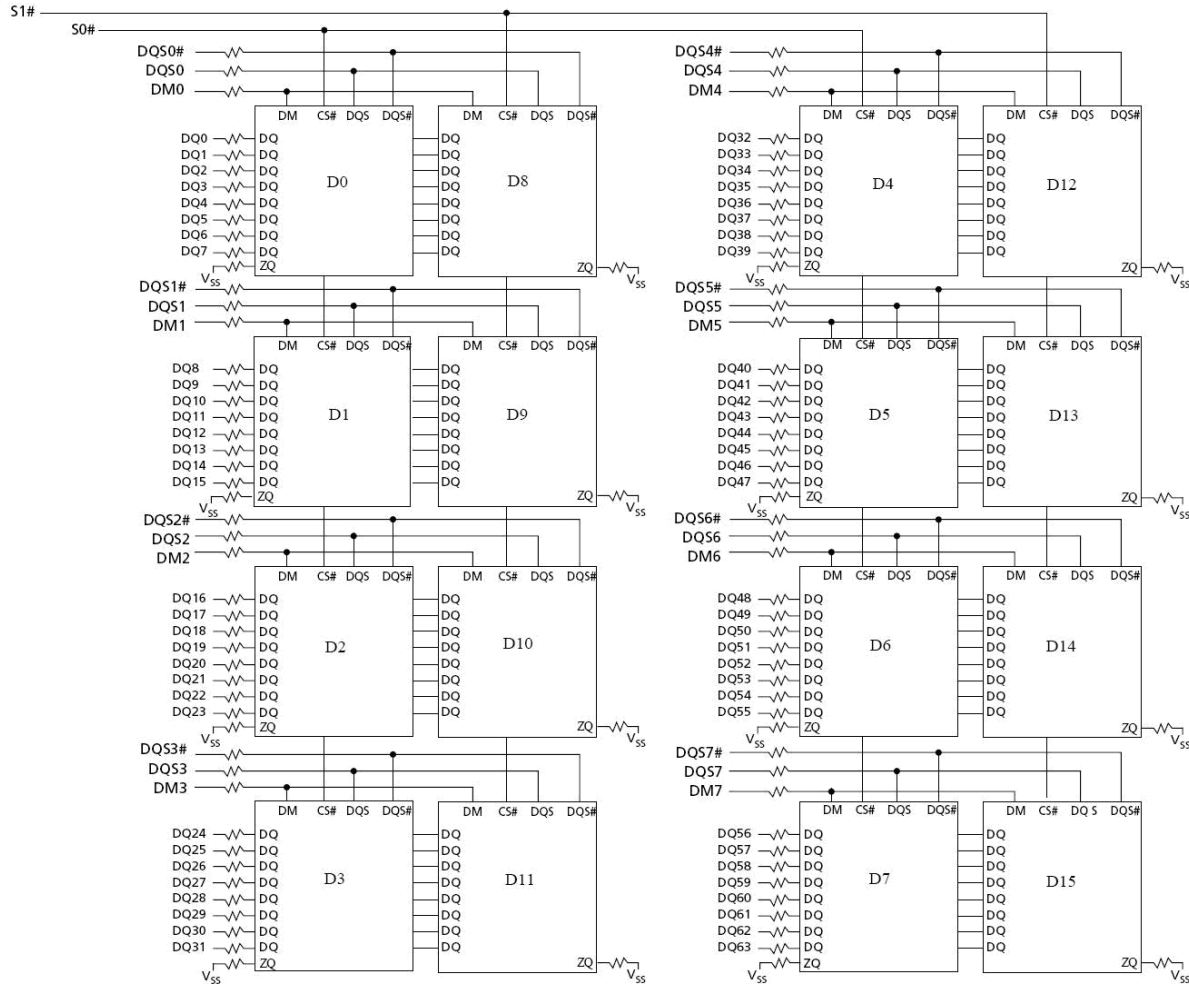

Command, address, control, and clock line terminations

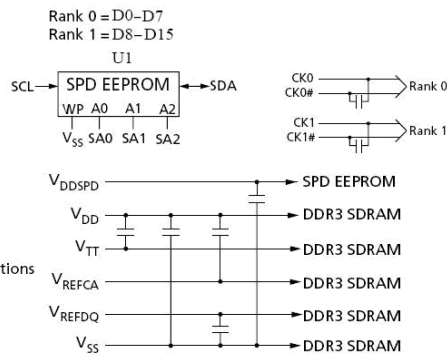
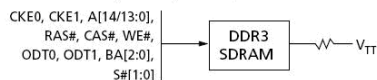

Note: 1. The ZQ ball on each DDR3 component is connected to an external 240Ω resistor that is tied to ground. Used for the calibration of the component's on-die termination and output driver.

Operating Temperature Condition

Parameter	Symbol	Rating	Unit	Note
Operating Temperature	TOPER	0 to 85	°C	1

Note: Operating Temperature is the case surface temperature on the center/top side of the DRAM. For the measurement conditions, please refer to JESD51-2 standard.

Absolute Maximum DC Ratings

Parameter	Symbol	Value	Unit	Note
Voltage on VDD relative to Vss	VDD	-0.4 ~ 1.975	V	1
Voltage on VDDQ pin relative to Vss	VDDQ	-0.4 ~ 1.975	V	1
Voltage on any pin relative to Vss	VIN, VOUT	-0.4 ~ 1.975	V	1
Storage temperature	TSTG	-55~+100	°C	1,2

Note: 1. Stress greater than those listed under “Absolute Maximum Ratings” may cause permanent damage to the device. This is a stress rating only and functional operation of the device at these or any other conditions above those indicated in the operational sections of this specification is not implied. Exposure to absolute maximum rating conditions for extended periods may affect reliability.
2. Storage Temperature is the case surface temperature on the center/top side of the DRAM. For the measurement conditions, please refer to JESD51-2 standard.

AC & DC Operating Conditions

Recommended DC operating conditions

Parameter	Symbol	Voltage	Rating			Unit	Notes
			Min	Typ.	Max		
Supply voltage	VDD	1.35V	1.283	1.35	1.45	V	1, 2
		1.5V	1.425	1.5	1.575	V	
Supply voltage for Output	VDDQ	1.35V	1.283	1.35	1.45	V	1, 2
		1.5V	1.425	1.5	1.575	V	
I/O Reference Voltage (DQ)	VREF _{DQ} (DC)	1.35V	0.49*VDDQ	0.50*VDDQ	0.51*VDDQ	V	3
I/O Reference Voltage (CMD/ADD)	VREF _{CA} (DC)	1.5V	0.49*VDDQ	0.50*VDDQ	0.51*VDDQ	V	3
AC Input Logic High	VIH(AC)	1.35V	VREF+0.160	-	-	V	
		1.5V	VREF+0.175	-	-	V	
AC Input Logic Low	VIL(AC)	1.35V	-	-	VREF-0.160	V	
		1.5V	-	-	VREF-0.175	V	
DC Input Logic High	VIH(DC)	1.35V	VREF+0.09	-	VDD	V	
		1.5V	VREF+0.1	-	VDD	V	
DC Input Logic Low	VIL(DC)	1.35V	VSS	-	VREF-0.09	V	
		1.5V	VSS	-	VREF-0.1	V	

Note: 1. Under all conditions VDDQ must be less than or equal to VDD.
2. VDDQ tracks with VDD, AC parameters are measured with VDD and VDDQ tied together.
3. Peak to peak AC noise on VREF may not allow deviate from VREF(DC) by more than +/-1% VDD.

IDD Specification parameters Definition - 8GB (2 Rank x8)

Parameter	Symbol	DDR3L 1600 CL11	Unit
Operating One bank Active-Precharge current; tCK = tCK(IDD), tRC = tRC(IDD), tRAS = tRASmin(IDD); CKE is HIGH, /CS is HIGH between valid commands;Address bus inputs are SWITCHING; Data bus inputs are SWITCHING	IDD0	350	mA
Operating One bank Active-read-Precharge current; IOUT = 0mA; BL = 8, CL = CL(IDD), AL = 0; tCK = tCK(IDD), tRC = tRC (IDD), tRAS = tRASmin(IDD), tRCD = tRCD(IDD); CKE is HIGH, /CS is HIGH between valid commands; Address bus inputs are SWITCHING; Data pattern is same as IDD4W	IDD1	440	mA
Precharge power-down current; All banks idle; tCK = tCK(IDD); CKE is LOW; Other control and address bus inputs are STABLE; Data bus inputs are FLOATING	IDD2P	170	mA
Precharge quiet standby current; All banks idle; tCK = tCK(IDD); CKE is HIGH, /CS is HIGH; Other control and address bus inputs are STABLE; Data bus inputs are FLOATING	IDD2Q	190	mA
Precharge standby current; All banks idle; tCK = tCK(IDD); CKE is HIGH, /CS is HIGH; Other control and address bus inputs are SWITCHING; Data bus inputs are SWITCHING	IDD2N	210	mA
Active power - down current; All banks open; tCK = tCK(IDD); CKE is LOW; Other control and address bus inputs are STABLE; Data bus inputs are FLOATING	IDD3P	180	mA
Active standby current; All banks open; tCK = tCK(IDD), tRAS = tRASmax(IDD), tRP = tRP(IDD); CKE is HIGH, /CS is HIGH between valid commands; Other control and address bus inputs are SWITCHING; Data bus inputs are SWITCHING	IDD3N	290	mA
Operating burst read current; All banks open, Continuous burst reads, IOUT = 0mA; BL = 4, CL = CL(IDD), AL = 0; tCK = tCK(IDD), tRAS = tRASmax(IDD), tRP = tRP(IDD); CKE is HIGH, /CS is HIGH between valid commands; Address bus inputs are SWITCHING; Data pattern is same as IDD4W	IDD4R	700	mA
Operating burst write current; All banks open, Continuous burst writes; BL = 8, CL = CL(IDD), AL = 0; tCK = tCK(IDD), tRAS = tRASmax(IDD), tRP = tRP(IDD); CKE is HIGH, /CS is HIGH between valid commands; Address bus inputs are SWITCHING; Data bus inputs are SWITCHING IDD4R	IDD4W	700	mA
Burst refresh current; tCK = tCK(IDD); Refresh command at every tRFC(IDD) interval; CKE is HIGH, /CS is HIGH between valid commands; Other control and address bus inputs are SWITCHING; Data bus inputs are SWITCHING	IDD5	1700	mA
Self refresh current; CK and /CK at 0V; CKE = 0.2V; Other control and address bus inputs are FLOATING; Data bus inputs are FLOATING	IDD6	240	mA
Operating bank interleave read current; All bank interleaving reads, IOUT = 0mA; BL = 8, CL = CL(IDD), AL = tRCD(IDD)-1*tCK(IDD); tCK = tCK(IDD), Trc = tRC(IDD), tRRD = tRRD(IDD), tRCD = 1*tCK(IDD); CKE is HIGH, CS is HIGH between valid commands;Address bus inputs are STABLE during DESELECTs; Data pattern is same as IDD4R;	IDD7	1180	mA

Note: 1.Module IDD was calculated on the specific brand DRAM(4xnm) component IDD and can be differently measured according to DQ loading capacitor.

Timing Parameters & Specifications

Speed		DDR3L 1600		Unit
Parameter	Symbol	Min	Max	
Average Clock Period	tCK	8	-	ns
CK high-level width	tCH	0.47	0.53	tCK
CK low-level width	tCL	0.47	0.53	tCK
DQS, /DQS to DQ skew, per group, per access	tDQSQ	-	125	ps
DQ output hold time from DQS, /DQS	tQH	0.38	-	tCK
DQ low-impedance time from CK, /CK	tLZ(DQ)	-450	225	ps
DQ high-impedance time from CK, /CK	tHZ(DQ)	-	225	ps
Data setup time to DQS, /DQS reference to Vih(ac)/Vil(ac) levels	tDS	10	-	ps
Data hold time to DQS, /DQS reference to Vih(ac)/Vil(ac) levels	tDH	45	-	ps
DQ and DM input pulse width for each input	tDIPW	360	-	ps
DQS, /DQS Read preamble	tRPRE	0.9	-	tCK
DQS, /DQS differential Read postamble	tRPST	0.3	-	tCK
DQS, /DQS Write preamble	tWPRE	0.9	-	tCK
DQS, /DQS Write postamble	tWPST	0.3	-	tCK
DQS, /DQS low-impedance time	tLZ(DQS)	-450	225	ps
DQS, /DQS high-impedance time	tHZ(DQS)	-	225	ps
DQS, /DQS differential input low pulse width	tDQSL	0.45	0.55	tCK
DQS, /DQS differential input high pulse width	tDQSH	0.45	0.55	tCK
DQS, /DQS rising edge to CK, /CK rising edge	tDQSS	-0.27	0.27	tCK
DQS, /DQS falling edge setup time to CK, /CK rising edge	tDSS	0.18	-	tCK
DQS, /DQS falling edge hold time to CK, /CK rising edge	tDSH	0.18	-	tCK
Delay from start of Internal write transaction to Internal read command	tWTR	Max (4tck, 7.5ns)	-	
Write recovery time	tWR	15	-	ns
Mode register set command cycle time	tMRD	4	-	tCK
/CAS to /CAS command delay	tCCD	4	-	nCK
Auto precharge write recovery + precharge time	tDAL	tWR+tRP/tck		nCK

Speed		DDR3L 1600		Unit
Parameter	Symbol	Min	Max	
Active to active command period for 1KB page size	tRRD	Max (4tck, 7.5ns)	-	ns
Active to active command period for 2KB page size	tRRD	Max (4tck, 6ns)	-	
Four Activate Window for 1KB page size	tFAW	30	-	ns
Power-up and RESET calibration time	tZQinitl	512	-	tCK
Normal operation Full calibration time	tZQoper	256	-	tCK
Normal operation short calibration time	tZQcs	64	-	tCK
Exit self refresh to commands not requiring a locked DLL	tXS	Max (5tCK, tRFC+10ns)	-	
Exit self refresh to commands requiring a locked DLL	tXSDLL	tDLL(min)	-	tCK
Internal read to precharge command delay	tRTP	Max (4tck, 7.5ns)	-	
Minimum CKE low width for Self refresh entry to exit timing	tCKESR	tCK(min)+1tCK	-	
Exit power down with DLL to any valid command: Exit Precharge Power Down with DLL	tXP	Max (3tCK, 6ns)	-	
CKE minimum pulse width (high and low pulse width)	tCKE	Max (3tCK, 5ns)		
Asynchronous RTT turn-on delay (Power-Down mode)	tAONPD	2	8.5	ns
Asynchronous RTT turn-off delay (Power-Down mode)	tAOFPD	2	8.5	ns
ODT turn-on	tAON	-225	225	ps
ODT turn-off	tAOF	0.3	0.7	tCK

SERIAL PRESENCE DETECT SPECIFICATION (AQD-D3L8GN16-SG1 Serial Presence Detect)

Byte	Function Described	Function	HEX Value
0	Number of Serial PD Bytes Written / SPD Device Size / CRC Coverage	CRC coverage 0~116Byte,SPD Total :256Byte, SPD Use : 176Byte	92
1	SPD Revision	Version 1.1	11
2	Key Byte / DRAM Device Type	DDR3 SDRAM	0B
3	Key Byte / Module Type	U-DIMM	02
4	SDRAM Density and Banks	8banks 4Gb	04
5	SDRAM Addressing	Row : 16 Column : 10	21
6	Module Nominal Voltage, VDD	1.35V/1.5V	02
7	Module Organization	2 Rank x8	09
8	Module Memory Bus Width	Non ECC 64bits	03
9	Fine Timebase Dividend and Divisor	2.5 ps	52
10	Medium Timebase Dividend	1/8 (0.125ns)	01
11	Medium Timebase Divisor		08
12	SDRAM Minimum Cycle Time (tCKmin)	1.25 ns	0A
13	Reserved	Reserved	00
14	CAS Latencies Supported, Least Significant Byte	CL5,6,7,8,9,10,11	FE
15	CAS Latencies Supported, Most Significant Byte	CL5,6,7,8,9,10,11	00
16	Minimum CAS Latency Time(tAAmin)	13.125 ns	69
17	Minimum Write Recovery Time (tWRmin)	15 ns	78
18	Minimum RAS# to CAS# Delay Time (tRCDmin)	13.125 ns	69
19	Minimum Row Active to Row Active Delay Time (tRRDmin)	6 ns	30
20	Minimum Row Precharge Time (tRPmin)	13.125 ns	69
21	Upper Nibbles for tRAS and tRC	-	11
22	Minimum Active to Precharge Time (tRASmin), Least Significant Byte	35 ns	18
23	Minimum Active to Active/Refresh Time (tRCmin), Least Significant Byte	48.125 ns	81
24	Minimum Refresh Recovery Time (tRFCmin), Least Significant Byte	260 ns	20
25	Minimum Refresh Recovery Time (tRFCmin), Most Significant Byte	260 ns	08
26	Minimum Internal Write to Read Command Delay Time (tWTRmin)	7.5 ns	3C
27	Minimum Internal Read to Precharge Command Delay Time (tRTPmin)	7.5 ns	3C
28	Upper Nibble for tFAW	30 ns	00
29	Minimum Four Activate Window Delay Time (tFAWmin), Least Significant Byte		F0
30	SDRAM Optional Features	DLL-Off , RZQ/6 , RZQ/7	83
31	SDRAM Thermal and Refresh Options	ASR / 85°C~95°C 2X refresh rate /95°C	05
32	Module Thermal Sensor	Non Thermal Sensor	00
33	SDRAM Device Type	-	00
34~59	Reserved, General Section	-	00
60	Module Nominal Height	30 mm	0F
61	Module Maximum Thickness	-	11
62	Reference Raw Card Used	Raw Card B Revision 0	01
63	Address Mapping from Edge Connector to DRAM	Mirrored	01
64-116	Reserved	-	00
117	Module Manufacturer ID Code, Least Significant Byte		04
118	Module Manufacturer ID Code, Most Significant Byte		CB
119	Module ID: Module Manufacturing Location	*Note: 1	-
120	Module ID: Module Manufacturing Date(Year)	*Note: 2	-
121	Module ID: Module Manufacturing Date(Week)	*Note: 3	-
122-125	Module ID : Module Serial Number	*Note: 4	-
126	Cyclical Redundancy Code	CRC-CCITT(LOW)	04
127	Cyclical Redundancy Code	CRC-CCITT(HIGH)	CD
128-145	Module Part Number	*Note: 5	-
146	Module Revision Code	-	00
147	Module Revision Code	-	00
148	SDRAM Manufacturer's JEDEC ID Code	-	00
149	SDRAM Manufacturer's JEDEC ID Code	-	00
150-151	Manufacturer's Specific Data	-	00
152-163	Manufacturer's Specific Data (Working Order Number)	*Note: 6	-
164-175	Manufacturer's Specific Data (SPD Naming Number)	*Note: 7	-
176-255	Open for customer use	*Note: 8	00

Note :

1. Byte 119 -- Manufacturing location by manufacturing location (00:Taiwan /01:China)
2. Byte 120 -- Module manufacturing date by year (YY).
3. Byte 121 -- Module manufacturing date by week (WW).
4. Bytes 122~125 -- Module Serial Number.
5. Bytes 128~145 -- Manufacturer Part Number by module part number , (Unused digits are coded as ASCII blanks (20h)).
6. Bytes 152~163 -- Manufacturer's Specific Data by working order number. (Unused digits are coded as 00h.)
7. Bytes 164~175 -- Manufacturer's Specific Data by SPD naming number. (Unused digits are coded as 00h.)
8. Bytes 176~255 --These bytes are undefined and can be used for ADATA's own purpose. (Unused digits are coded as 00h.)

Tento produkt můžete zakoupit u společnosti AutoCont IPC a.s.



AutoCont IPC a.s.

Váš dodavatel průmyslových počítačů, komponent a speciálních průmyslových IT systémů.

 Uhlířská 1064/3, 710 00 Ostrava, Česká republika

 obchod@autocont-ipc.cz

 +420 552 301 002

 www.autocont-ipc.cz



PRŮMYSLOVÉ POČÍTAČE

fanless embedded PC, do racku, ...



POČÍTAČE S DISPLEJEM

panelové PC, terminály, do vozidel, ...



AUTOMATIZACE A SBĚR DAT

převodníky, karty, moduly, switche, ...



PERIFERIE A KOMPONENTY

monitory, klávesnice, desky, skříně, ...



NOTEBOOKY A TABLETY

odolné, windows, android, IP65, ...



INFORMAČNÍ KIOSKY

interiérové, venkovní, ...



MEDICÍNSKÁ TECHNIKA

počítače, tablety, LCD, klávesnice, ...



SOFTWAREVÁ ŘEŠENÍ

pro výrobu, zaměstnance, kiosky, ...



PŘEJÍT DO E-SHOPU

eshop.autocont-ipc.cz



DOPRAVA ZDARMA

Doprava zdarma v ČR a SR při objednávce nad 10 000 Kč bez DPH nebo nad 400 EUR.



PRODLOUŽENÁ ZÁRUKA

Záruka 2 roky na vyráběné počítače s možností jejího prodloužení až na 5 let.



ODMĚNA ZA VĚRNOST

Pravidelní zákazníci u nás nakupují za nižší ceny. Výše slevy se odvíjí od realizovaného obrátu.



SERVIS ON-SITE A IN-TIME

K projektovým dodávkám nabízíme rozšířenou podporu a servis s garancí výměny zařízení do 48 hodin.